

Contemporary design



organizer/listino 2023

Contemporary design

Materiale versatile, dinamico, fresco adatto per vestire ogni ambiente domestico secondo il proprio stile e la propria personalità. Le differenti superfici sono la giusta risposta anche per le applicazioni commerciali a medio e basso traffico.

A versatile, dynamic, new material suitable for clothing any domestic environment according to one's own style and personality. The different surfaces are the perfect solution even for commercial applications with medium to low footfall.

Matériau polyvalent, dynamique et actuel, idéal pour le revêtement de tout environnement domestique en s'adaptant au style et à la personnalité de chacun. Les différentes surfaces offrent également une solution idéale pour les applications commerciales à trafic moyen et faible.

Vielseitig einsetzbares, dynamisches, frisch wirkendes Material, das sich auf den individuellen Stil und die Persönlichkeit eines jeden Wohnambiente abstimmen lässt. Die verschiedenen Flächenbeläge sind auch für wenig bis mittelhoch frequentierte gewerbliche Bereiche die ideale Lösung.

Material versátil, dinámico y fresco, ideal para vestir cualquier ambiente doméstico con su propio estilo y personalidad. Las diferentes superficies son la respuesta perfecta también para aplicaciones comerciales de mediano y bajo tránsito.

versatility



freshness



functionality



simplicity

Indice



gres porcellanato smaltato

glazed porcelain stoneware / gres cérame émaillé
glasierte Feinsteinzeug / gres porcelánico esmaltado

12/19	Antique marble
20/29	Artifact
38/51	Elemental stone
52/59	Exalt
60/67	Hi-wood
68/77	Maps
98/107	Natural stone
108/115	Onyx
116/127	Rock salt
128/135	Timeless

gres fine porcellanato

fine porcelain stoneware / grès cérame fin
feinsteinzeug-kollektionen / gres porcelánico fino

28/29	Artifact 20mm
30/37	Crayons
50/51	Elemental stone 20mm
76/77	Maps 20mm
78/97	Match-up
106/107	Natural stone 20mm
126/127	Rock salt 20mm
136/147	Woodslate life



La simbologia

SYMBOL/SYMBOLS/SYMBOL/SIMBOLOGIA

DIN 16165 ANNEX B: Scivolosità a piedi calzati: il materiale ceramico viene posto su un piano e oliato. Successivamente il piano viene progressivamente inclinato, mentre un operatore con scarpa di gomma cammina lungo il piano fino a quando non inizia a scivolare; la misura dell'angolo che si forma tra il piano inclinato e il suolo all'inizio dello scivolamento determina la classificazione del materiale. / Shod foot slipperiness: the ceramic material is placed on a surface and oiled. Subsequently, the surface is progressively tilted, while an operator with rubber shoes walks along the surface until he starts to slip; the measurement of the angle that is formed between the inclined surface and the ground when the slipping starts determines the classification of the material. / Glissance pieds chaussés : le matériau céramique est mis sur un plan et huilé. Le plan est ensuite incliné progressivement, tandis qu'un opérateur avec des chaussures en caoutchouc marche le long du plan jusqu'à ce qu'il ne commence à glisser ; la mesure de l'angle qui se forme entre le plan incliné et le sol au début du glissement donne la classification du matériau. / Rutschsicherheit auf Schuhen: Das Keramikmaterial wird auf einer Fläche angebracht und mit einem Gleitmittel bestrichen. Daraufhin wird die Fläche nach und nach geneigt, während eine Prüfperson mit Gummischuhen die Fläche entlangläuft, bis sie ins Rutschen gerät. Die Größe des Winkels, der zwischen der geneigten Fläche und dem Boden zu Beginn der Rutschbewegung entsteht, bestimmt die Klassifizierung des Materials. / Deslizamiento con pies descalzos: el material cerámico se coloca sobre un plano y se aceita. Seguidamente el plano se inclina progresivamente, mientras que un operador con calzado de goma camina a lo largo del plano hasta que empieza a resbalar; la medida del ángulo que se forma entre la superficie inclinada y el suelo al principio del deslizamiento determina la clasificación del material.

DIN 16165 ANNEX A: Scivolosità a piedi nudi: il materiale ceramico viene posto su un piano e bagnato. Successivamente il piano viene progressivamente inclinato, mentre un operatore con piede nudo cammina lungo il piano fino a quando non inizia a scivolare; la misura dell'angolo che si forma tra il piano inclinato e il suolo all'inizio dello scivolamento determina la classificazione del materiale. / Barefoot slipperiness: the ceramic material is placed on a surface and made wet. Subsequently, the surface is progressively tilted, while an operator with bare feet walks along the surface until he starts to slip; the measurement of the angle that is formed between the inclined plane and the ground when slipping starts determines the classification of the material. / Glissance pieds nus : le matériau céramique est mis sur un plan et mouillé. Le plan est ensuite incliné progressivement, tandis qu'un opérateur pieds nus marche le long du plan jusqu'à ce qu'il ne commence à glisser ; la mesure de l'angle qui se forme entre le plan incliné et le sol au début du glissement donne la classification du matériau. / Rutschsicherheit barfuß: Das Keramikmaterial wird auf einer Fläche angebracht und befeuchtet. Daraufhin wird die Fläche nach und nach geneigt, während eine Prüfperson barfuß die Fläche entlangläuft, bis sie ins Rutschen gerät. Die Größe des Winkels, der zwischen der geneigten Fläche und dem Boden zu Beginn der Rutschbewegung entsteht, bestimmt die Klassifizierung des Materials. / Deslizamiento con pies descalzos: el material cerámico se pone sobre un plano y se moja. Seguidamente el plano se inclina progresivamente, mientras que un operador con los pies descalzos camina a lo largo del plano hasta que empieza a resbalar; la medida del ángulo que se forma entre la superficie inclinada y el suelo al principio del deslizamiento determina la clasificación del material.

DCOF: Coefficiente di attrito dinamico: viene misurata la forza necessaria per mantenere in movimento un elemento (BOT 3000) rivestito in gomma dalla superficie della piastrella in condizioni di superficie bagnata; il rapporto tra la forza necessaria e il peso dell'elemento scivolante indica il Coefficiente di attrito dinamico. / Dynamic coefficient of friction: the force required to maintain the movement of an element (BOT 3000) coated with rubber on the surface of the tile in wet surface conditions is measured; the relationship between the force required and the weight of the slipping element indicates the dynamic coefficient of friction. / Coefficient de frottement dynamique : la force nécessaire pour maintenir en mouvement un élément (BOT 3000) revêtu en caoutchouc sur la surface du carreau en conditions de surface mouillée est mesurée ; la relation entre la force nécessaire et le poids de l'élément glissant indique le coefficient de frottement dynamique. / Dynamischer Reibungskoeffizient: Gemessen wird die Kraft, die erforderlich ist, um ein Element mit Gummiverkleidung (BOT 3000) durch die Fliese bei nasser Oberfläche in Bewegung zu halten. Das Verhältnis zwischen der erforderlichen Kraft und dem Gewicht des gleitenden Elements gibt den dynamischen Reibungskoeffizienten wieder. / Coeficiente de fricción cinética: se mide la fuerza necesaria para mantener en movimiento un elemento (BOT 3000) revestido de goma por la superficie de la baldosa bajo condiciones de superficie mojada; la relación entre la fuerza necesaria y el peso del elemento que resbala indica el Coeficiente de fricción dinámica.

SQUADRATO / SQUARED / EQUARRI / REKTIFIZIERT / ESCUADRADO

Piastrelle o lastre ceramiche portate a dimensioni predefinite, ognuno esattamente uguale all'altra (monocalibro) con sistema di mole abrasive. Ceramic tiles or slabs made to a pre-defined size, each one exactly the same as the others (single size), using a system of abrasive grinders. / Carreaux ou dalles céramiques mises aux dimensions prédéfinies, parfaitement identiques l'une à l'autre (mono-calibre) grâce à un système de disques abrasifs. / Fliesen oder Keramikplatten mit festgelegten Formaten. Alle Fliesen sind aufgrund der Verwendung des Schleifscheiben-Systems hundertprozentig identisch (Monokaliber). / Baldosas o piezas de cerámica que se realizan con dimensiones predefinidas, cada pieza es exactamente igual a la otra (mono dimensión) con sistema de discos abrasivos.

Grado di variazione cromatica

DEGREE OF COLOUR CHANGE/DEGRE DE VARIATION CHROMATIQUE/GRAD DER FARBABWEICHUNG/GRADO DE VARIACIÓN CROMÁTICA

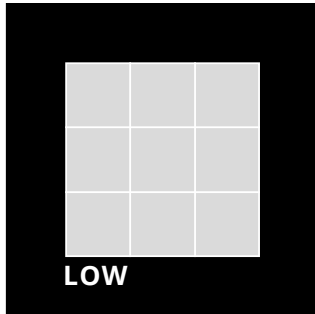

v1

PRODOTTO MONOCROMATICO.

The least amount of shade and texture variation.

Attainable in naturally fired clay products.

Produit monochromatique.

Eifarbiges produkt.

Producto monocromático.

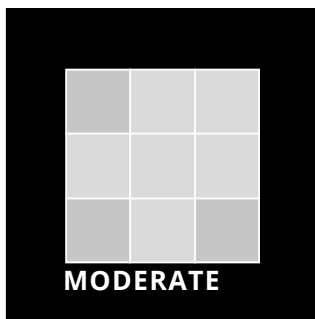

v2

PRODOTTO CON LEGGERA VARIAZIONE CROMATICA.

Light to moderate shade and texture variation within each carton.

Produit à légère variation chromatique.

Produkt mit leichter farbnuance.

Producto con una pequeña variación cromática.

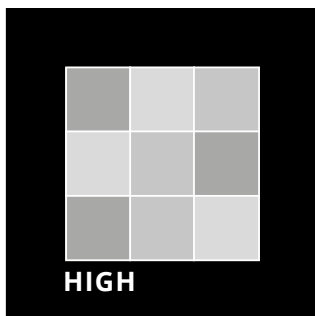

v3

PRODOTTO CON MARCATA VARIAZIONE CROMATICA.

High shade texture variation within each carton.

Produit à variation chromatique accentuée.

Produkt mit ausgeprägter farbnuance.

Producto con evidente variación cromática.

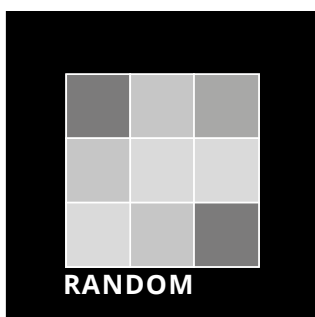

v4

PRODOTTO CON FORTE VARIAZIONE CROMATICA.

Very high shade and texture variation within each carton.

Produit à forte variation chromatique.

Produkt mit starker farbnuance.

Producto con fuerte variación cromática.

Superfici

SURFACES/SURFACES/OBERFLÄCHEN/SUPERFICIES

Naturale / Matte / Mat / Matt / Mate

Superficie risultante dalla produzione di piastrella pressata senza lavorazioni successive alla cottura. / Surface coming from manufacturing pressed tiles without further work after firing. / Surface résultant de la production d'un carreau pressé sans être travaillé après la cuisson. / Die Oberfläche entsteht durch das Fliesenpressverfahren - im Anschluss an das Brennen erfolgt keine weitere Bearbeitung. / Superficie que resulta de la producción de baldosa prensada sin ulteriores elaboraciones después de la cocción.

Strutturato - Grip / Structured / Structuré / Strukturiert / Estructurado

Superficie risultante dalla produzione di piastrella pressata, a tampone non liscio con intensità di evidenza variabile (da leggera ondulazione ad imitazione di pietra tagliata), senza lavorazioni successive alla cottura. / Surface coming from manufacturing pressed tiles, using a rough pad with variable intensity (from a slightly undulating one to inspired cut stone), without processing after firing. / Surface résultant de la production d'un carreau pressé, par un tampon à relief avec une intensité d'aspect variable (de légère ondulation à l'inspiration de la pierre taillée), sans être travaillé après la cuisson. / Die Oberfläche beruht auf dem Produktionsverfahren der Fliesenpressung unter Verwendung eines unglatten Stempels mit Intensitätsvariation (leichte Wellung entsprechend eines geschnittenen Steins). Es erfolgt keine Weiterbearbeitung nach dem Brennen. / Superficie que resulta de la producción de baldosa prensada, con tampón no liso con intensidad de evidencia variable (de ligera ondulación a imitación de piedra cortada), sin ulteriores elaboraciones después de la cocción.

Bocciardato / Bush-hammered / Bouchardé / Gehämmert / Abujardado

Superficie risultante dalla produzione di piastrella sottoposta, dopo la pressatura ma prima della cottura, a lavorazione meccanica consistente nell'asportazione irregolare di uno strato di materia per ottenere una superficie come per la pietra assolutamente naturale (antiscivolo), con leggere differenze non ripetibili tra una piastrella ed un'altra. / Surface coming from manufacturing tiles subjected to mechanical processing consisting of irregularly removing a layer of material after pressing but before firing in order to obtain a surface like absolutely pure natural stone (non slip), with slight unrepeatable differences between one tile and another. / Surface résultant de la production d'un carreau soumis, après le pressage mais avant la cuisson, à un travail mécanique qui consiste à éliminer de façon irrégulière une épaisseur de matière afin d'obtenir une surface semblable à la pierre naturelle tout à fait naturelle (anti-glisser), avec de légères différences variant d'un carreau à l'autre. / Zur Gewinnung dieser Oberfläche wurde die Fliese im Anschluss an die Pressung und vor dem Brennen einer mechanischen Bearbeitung zur Abtragung von Unregelmäßigkeiten einer Materialschicht unterzogen. Mit Hilfe dieses Verfahrens wird eine absolut natürliche und dem Naturstein entsprechende (rutschfeste) Oberfläche erzielt, die für geringfügige, aber einmalige Unterschiede unter den Fliesen verantwortlich ist. / Superficie que resulta de la producción de baldosa sometida, después del prensado pero antes de la cocción, a un proceso mecánico consistente en la eliminación irregular de una capa de materia para obtener una superficie como la piedra totalmente natural (resistente al deslizamiento), con ligeras diferencias que no se repiten entre una baldosa y otra.

Lucido - Glossy

Superficie ottenuta dopo la cottura sottoponendo le lastre a spazzolatura e lucidatura meccanica con serie di utensili abrasivi a grana decrescente. La superficie finale è morbida, lucida e riflettente. / Surface obtained after firing subjecting the slabs to mechanical brushing and polishing with a series of decreasing grain abrasive utensils. The final surface is soft, glossy and reflective. / Surface obtenue après cuisson, en soumettant les dalles à un brossage et un polissage mécanique avec un jeu d'outils abrasifs de grain décroissant. La surface finale est douce, brillante et réfléchissante. / Oberfläche, die nach dem Brand erhalten wurde, indem Platten mit einer Serie von Reibwerkzeugen mit kleiner werdender Struktur einer mechanischen Bürstung und Politur unterzogen wurde. Die fertige Oberfläche ist weich, glänzend und reflektierend. / Superficie obtenida después de la cocción sometiendo las losas a un procedimiento de cepillado y pulido mecánico con una serie de utensilios abrasivos de grano decreciente. La superficie final es suave, brillante y reflectante.

Superficie R+PTV / R+PTV Surface / Surface R+PTV / Oberfläche R+PTV / Superficie R+PTV

Superficie ottenuta dalla produzione di piastrella con tampone opportunamente sagomato così da raggiungere precise caratteristiche di sicurezza misurate secondo i principali metodi normativi in uso. La superficie finale è leggermente ruvida, opaca e conforme ai requisiti di scivolosità R10 (norma di riferimento DIN EN 16165 ANNEX B) e scivolosità Pendolo >36 wet (slider 96, norma di riferimento BS EN 16165 ANNEX C -AS/NZS 4586). Surface obtained from the production of tiles with appropriately shaped die in order to achieve precise safety characteristics measured based on the main prevailing regulatory methods in use. The final surface is slightly rough, matt and complies with R10 slipperiness requirements (reference standard DIN EN 16165 ANNEX B) and Pendulum slipperiness >36 wet (slider 96, reference standard BS EN 16165 ANNEX C -AS/NZS 4586). / Surface obtenue à partir de la production de carreaux avec tampon opportunément façonné de manière à satisfaire des caractéristiques de sécurité précises, mesurées suivant les principales méthodes réglementaires en vigueur. La surface finale est légèrement rugueuse, mate et répond aux exigences de la classe de glissance R10 (norme de référence DIN EN 16165 ANNEX B) et de glissance - test du pendule - humide - valeur >36 (slider 96, norme de référence BS EN 16165 ANNEX C -AS/NZS 4586). / Durch die Produktion von Fliesen mit entsprechend geformter Kachelunterlage erhaltene Oberfläche, um präzise Sicherheits-Charakteristiken zu erzielen, gemessen nach den wichtigsten angewandten Regelungsmethoden. Die fertige Oberfläche ist leicht angeraut, matt und konform mit den rutschhemmenden Eigenschaft R10 (Bezugsnorm DIN EN 16165 ANNEX B) und der Rutschfestigkeit Pendolo >36 wet (slider 96, Bezugsnorm BS EN 16165 ANNEX C -AS/NZS 4586). / Superficie obtenida de la producción de baldosas con un molde específicamente fabricado para alcanzar características precisas de seguridad de conformidad con los principales métodos normativos vigentes. La superficie final es ligeramente áspera, opaca y conforme a los requisitos de resistencia al deslizamiento R10 (norma de referencia DIN EN 16165 ANNEX B) y resistencia al deslizamiento Péndulo >36 mojado (slider 96, norma de referencia BS EN 16165 ANNEX C -AS/NZS 4586).

Comfort

La nuova superficie Comfort è frutto dello storico know-how industriale della nostra azienda e rappresenta una vera e propria rivoluzione nell'utilizzo del prodotto ceramico. Comfort unisce il tatto morbido e piacevole delle finiture naturali con prestazioni tecniche sulla scivolosità (R10 classe B e PTV>36) che la rendono particolarmente indicata nelle applicazioni pubbliche e commerciali, anche in condizioni di umidità e bagnato. / The new Comfort surface is the outcome of our company's historic industrial know-how and represents a real revolution in the use of ceramic products. Comfort combines the soft, pleasant feel of a matte surface with anti-slip technical performances (R10 class B and PTV >36) that make it particularly suitable for public and commercial applications, including in wet and humid conditions. / La nouvelle surface Comfort est l'aboutissement de l'historique savoir-faire industriel de notre entreprise. Elle révolutionne littéralement l'emploi du produit céramique. Comfort allie le toucher doux et agréable des finitions naturelles aux performances techniques sur la glissance (R10 classe B et PTV >36). La surface est ainsi tout particulièrement indiquée dans les applications publiques et commerciales, y compris dans les lieux humides et mouillés. / Die neue Oberfläche Comfort basiert auf dem langjährigen produktionstechnischen Know-how unseres Unternehmens und steht für eine echte Revolution in der Verwendung keramischer Produkte. Comfort vereint die angenehm weiche Haptik einer natürlichen Oberfläche mit technischen Eigenschaften in punkto Rutschhemmung (R10 Klasse B und PTV>36), die das Produkt für den Einsatz in öffentlichen und gewerblichen Bereichen, und zwar auch bei Feuchtigkeit und Nässe, prädestinieren. La nueva superficie Comfort es fruto del histórico saber hacer industrial de nuestra empresa y representa una auténtica revolución en el uso del producto cerámico. Comfort aún el tacto suave y agradable del acabado natural con unas prestaciones técnicas de resistencia al deslizamiento (R10 clase B y PTV>36) que la convierten en particularmente indicada para aplicaciones públicas y comerciales, incluso en condiciones de humedad y de mojado.

Tabella Imballi

PACKAGE TABLE - TABLEAU DE EMBALLAGES - TABELLE FORMATE - TABLA DE LOS EMBALAJES

	scatola - box			pallet		
	pz	mq	kg	box	mq	kg

imballi per scatola
packages for boxes
emballages pour boîte
verpackungen für schachteln
embalajes para cajas

imballi per pallet
packages for pallets
emballages pour palette
verpackungen für paletts
embalajes para paletas

Tabella gruppi di prezzo

TABLE OF PRICE RANGES - TABLEAU GROUPE DES PRIX - TABELLE PREISGRUPPEN - TABLA DE GRUPO DE PRECIOS

Descrizione simboli / Description of symbols / Description symboles / Zeichenerklärung / Descripción de los símbolos			
■	▲	●	◆
PREZZO PER MATERIALE GESTITO A METRO QUADRO	*PREZZO PER MATERIALE GESTITO A PEZZO	PREZZO PER MATERIALE GESTITO A NUMERO/COMPOSIZIONE	PREZZO PER MATERIALE GESTITO A METRO LINEARE
Price for materials managed per square metre. Prix pour matériau géré au mètre carré Materialpreis pro Quadratmeter Precio del material por metro cuadrado	Price for materials managed per piece Prix pour matériau géré à la pièce Materialpreis pro stück Precio del material por pieza	Price for materials managed per number/composition Prix pour matériau géré à nombre/composition Materialpreis pro anzahl/zusammenstellung Precio del material por número/composición	Price for materials managed lm Prix pour matériau géré à mètre linéaire Materialpreis pro Lfm Precio del material por ml
*costo al pezzo, vendita a scatola completa price per piece, sold by full boxes only • prix à la pièce, vente à la boîte complète • stückpreis bei voller kartonabnahme • precio à la pieza, venta à caja completata			

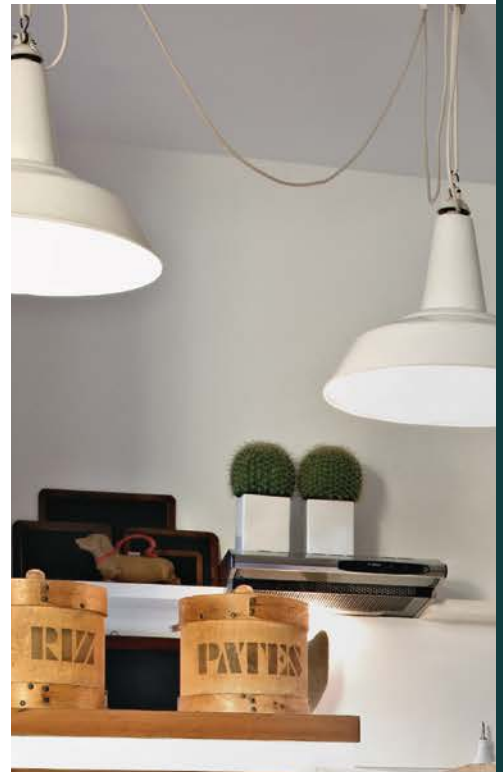

ANTIQUÉ MARBLE

gres porcellanato smaltato
glazed porcelain stoneware
gres cérame émaillé
glasierte Feinsteinzeug
gres Porcelánico esmaltado





ANTIQUÉ MARBLE

Nella scia del successo della serie Timeless, Contemporary design propone altre 4 essenze ispirate dalla bellezza delle materie naturali. **Antique Marble** sprigiona la forza straordinaria dei marmi e delle pietre che evocano antico e contemporaneo in un connubio unico riuscendo ad esprimerne l'eleganza intrinseca che si lega indissolubilmente alla sua estrema funzionalità. Una collezione che attraverso differenti finiture, formati e variazioni cromatiche può accontentare le tante esigenze dell'architettura e dei diversi stili di vita, mantenendo una concreta coerenza nei confronti del passato.

Following the success of its Timeless series, Contemporary design presents another 4 series inspired by the beauty of natural materials. **Antique Marble** unleashes the force of marble and stone, marrying ancient to modern in a uniquely elegant style without compromising the need for extreme functionality. The collection exploits a variety of finishes, sizes and colour themes to satisfy the demands of contemporary architecture and modern lifestyles, without losing its connection to its roots in the past.

Dans la lignée du succès de la collection Timeless, Contemporary design propose 4 autres essences inspirées de la beauté des matières naturelles. **Antique Marble** libère la force extraordinaire des marbres et des pierres qui rapprochent dans une alliance unique l'ancien et le contemporain, exprimant une élégance intrinsèque indissociable d'une fonctionnalité extrême. Une collection qui, à travers des finitions, des variations chromatiques et des formats différents, satisfait les exigences innombrables de l'architecture et de modes de vie multiples, en maintenant une cohérence concrète vis-à-vis du passé.

Im Zuge des Erfolgs der Serie Timeless bietet Contemporary design weitere 4 Essenzen an, die von der Schönheit der natürlichen Materialien inspiriert wurden. **Antique Marble** strahlt die außerordentliche Kraft des Marmors und der Steine aus, die Antikes und Zeitgenössisches in einer einzigartigen Verbindung heraufbeschwören und dabei die immanente Eleganz ausdrücken, die sich untrennbar mit der außerordentlichen Funktionalität verbindet. Eine Kollektion, die durch unterschiedliches Finish, wechselnde Formate und farbliche Variationen den vielen Ansprüchen der Architektur und der heterogenen Lebensstile gerecht werden kann und dabei der Vergangenheit gegenüber eine konkrete Kohärenz bewahrt.

Siguiendo el éxito de la serie, Timeless Contemporary design propone otras 4 esencias inspiradas por la belleza de las materias naturales. **Antique Marble** da rienda suelta a la fuerza extraordinaria de los mármoles y las piedras que evocan lo antiguo y lo contemporáneo en una unión única, consiguiendo expresar la elegancia intrínseca que se une de manera indisoluble a su extremada funcionalidad. Una colección que, mediante varios acabados, formatos y variaciones cromáticas, puede satisfacer las muchas necesidades de la arquitectura y los diferentes estilos de vida, manteniendo una coherencia concreta frente al pasado.

ANTIQUÉ MARBLE

GHOST MARBLE_01



PURE MARBLE_02

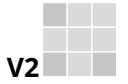

V2

DCOF>
0,42 Wet
(naturale)

9 mm 3/8" ↑↓

GRES PORCELLANATO SMALTATO

GLAZED PORCELAIN STONEWARE / GRES CÉRAMÉ ÉMAILLÉ / GLASIERTE FEINSTEINZEUG / GRES PORCELÁNICO ESMALTADO
SQUADRATO - SQUARED - EQUARRI - REKTIFIZIERT - ESCUADRADO

9 mm 3/8" ↑↓	COLOR	SURFACE	60x120 23 ^{5/8} "x47 ^{1/4} "	60x60 23 ^{5/8} "x23 ^{5/8} "	30x60 11 ^{4/5} "x23 ^{5/8} "
ANTIQUÉ MARBLE	GHOST MARBLE_01	NATURALE	754701 ■ FL-06700	754724 ■ FL-05100	754743 ■ FL-04400
		LUCIDO	754695 ■ FL-08100	754717 ■ FL-06500	754737 ■ FL-05500
	PURE MARBLE_02	NATURALE	754704 ■ FL-06700	754726 ■ FL-05100	754745 ■ FL-04400
		LUCIDO	754697 ■ FL-08100	754719 ■ FL-06500	754739 ■ FL-05500

IMPERIAL MARBLE_04



PANTHEON MARBLE_06





DCOF>
0,42 Wet
(naturale)







9 mm 3/8" ↑↓

GRES PORCELLANATO SMALTATO





GLAZED PORCELAIN STONEWARE / GRES CÉRAMÉ ÉMAILLÉ / GLASIERTE FEINSTEINZEUG / GRES PORCELÁNICO ESMALTADO
SQUADRATO - SQUARED - EQUARRI - REKTIFIZIERT - ESCUADRADO

9 mm 3/8" ↑↓		COLOR	SURFACE	60x120 23 ⁵ / ₈ "x47 ¹ / ₄ "	60x60 23 ⁵ / ₈ "x23 ⁵ / ₈ "	30x60 11 ⁴ / ₅ "x23 ⁵ / ₈ "
ANTIQUE MARBLE		IMPERIAL MARBLE_04	NATURALE	754700 ■ FL-06700	754722 ■ FL-05100	754742 ■ FL-04400
			LUCIDO	754694 ■ FL-08100	754716 ■ FL-06500	754736 ■ FL-05500
		PANTHEON MARBLE_06	NATURALE	754705 ■ FL-06700	754727 ■ FL-05100	754746 ■ FL-04400
			LUCIDO	754698 ■ FL-08100	754720 ■ FL-06500	754740 ■ FL-05500

ANTIQUE MARBLE

9 mm 3/8" ↑↓		COLOR	SURFACE	30x30 11 4/5" x 11 4/5"  mosaico tessere 3x3 pz/box 11	30x30 11 4/5" x 11 4/5"  mosaico 3D 5x30 pz/box 8	0,5x60 1/4" x 23 5/8" matita inox pz/box 4 719674 ▲ FL-03100
ANTIQUE MARBLE		GHOST MARBLE_01	NATURALE	754826 ▲ FL-01600	754814 ▲ FL-01900	
			LUCIDO	754820 ▲ FL-01800	754808 ▲ FL-02100	
		PURE MARBLE_02	NATURALE	754827 ▲ FL-01600	754815 ▲ FL-01900	
			LUCIDO	754821 ▲ FL-01800	754809 ▲ FL-02100	
		IMPERIAL MARBLE_04	NATURALE	754829 ▲ FL-01600	754817 ▲ FL-01900	
			LUCIDO	754823 ▲ FL-01800	754811 ▲ FL-02100	
	PANTHEON MARBLE_06	NATURALE	754831 ▲ FL-01600	754819 ▲ FL-01900		
		LUCIDO	754825 ▲ FL-01800	754813 ▲ FL-02100		

PEZZI SPECIALI/SPECIAL TRIMS/PIÈCES SPÉCIALES/FORMSTÜCKE/PIEZAS ESPECIALES

9 mm 3/8" ↑↓		COLOR	SURFACE	4,6x60 1 4/5" x 23 5/8"  battiscopa
ANTIQUE MARBLE		GHOST MARBLE_01	NATURALE	754844 ◆ FL-01600
			LUCIDO	754838 ◆ FL-01600
		PURE MARBLE_02	NATURALE	754846 ◆ FL-01600
			LUCIDO	754839 ◆ FL-01600
		IMPERIAL MARBLE_04	NATURALE	754848 ◆ FL-01600
			LUCIDO	754841 ◆ FL-01600
	PANTHEON MARBLE_06	NATURALE	754850 ◆ FL-01600	
		LUCIDO	754843 ◆ FL-01600	



GHOST MARBLE_01/ PURE MARBLE_02/PANTHEON MARBLE_06

3D: Si consiglia la posa con stucco epossidico per ambienti bagnati o sottoposti a forte umidità. / 3D: We recommend laying with epoxy putty for wet environments or those subject to strong humidity. / 3D: pose conseillée avec mortier époxy pour environnements très humides ou mouillés. / 3D: In nassen oder starker Feuchtigkeit ausgesetzten Bereichen empfiehlt sich die Verlegung mit Epoxidstuck. / 3D: En ambientes mojados o muy húmedos, se recomienda realizar la colocación con estuco epoxidico.

Per un effetto ottimale della posa, florim suggerisce di mantenere 2 mm di fuga per pose monofornate e 3 mm per combinare formati misti. - For optimal installation results, florim recommends maintaining a joint of 2 mm 1/12" for single format installations and 3 mm 1/8" to combine mixed formats. - Pour réaliser une pose parfaite, florim suggère de maintenir 2 mm de joint pour la pose des monofornats, et 3 mm pour les combinaisons de formats mixtes. - Um einen optimalen effekt beim verlegen zu erzielen empfiehlt florim eine 2 mm fughe bei einformatigen verlegungen und 3 mm fughe bei formatkombinationen Para lograr los máximos resultados en la posa del producto, florim aconseja 2 mm de junta en aplicaciones monofornate y 3 mm en combinaciones de formatos mixtos

ANTIQUE MARBLE	scatola - box			pallet		
	pz	mq	kg	box	mq	kg
30x60	6	1,08	21,49	40	43,20	890
60x60	3	1,08	21,49	40	43,20	890
60x120	2	1,44	28,08	30	43,20	870

ANTIQUE MARBLE	scatola - box			pallet		
	pz	ml	kg	box	mq	kg
4,6x60 battiscopa	14	8,40	8,40	-	-	-





ARTIFACT

gres porcellanato smaltato
glazed porcelain stoneware
gres cérame émaillé
glasierte Feinsteinzeug
gres Porcelánico esmaltado





ARTIFACT

Una materia cosmopolita che trasforma in soggetto attivo ogni spazio in cui si propone e asseconda il vissuto di chi vi abita creando un sentimento di armonia e complicità. **Artifact** si richiama al sapore semplice del cemento spatolato ottenuto artigianalmente da mani sapienti in cui il valore dell'unicità diventa segno distintivo, fattore identitario che svela il gusto di chi la sceglie per il proprio quotidiano. Estetica e funzionalità si fondono in uno stile illuminato che sprigiona una inattesa modernità. L'imperfezione come scelta dichiarata esprime il desiderio di combinare tecnologia e artigianato, precisione tecnica e immaginazione senza dimenticare il gusto per la sperimentazione. Una trama leggera e delicata da guardare e soprattutto da sfiorare per percepirne appieno la sua morbida matericità.

A cosmopolitan material that transforms any space to which it is applied into an active element and contributes to the life experience of those who live there by creating a feeling of harmony and complicity. **Artifact** harks back to the simple flavour of plastered cement obtained by a skilled craftsman, where its unique value becomes a distinguishing feature, an element to identify it that reveals the taste of the person who chooses it for his or her own daily existence. Aesthetic quality and functionality blend into an enlightened style, generating an unexpected contemporary feel. Imperfection as a stated choice expresses the desire to combine technology and craftsmanship, technical precision and imagination, not forgetting a taste for experimentation. It is a light-hearted, delicate pattern to be gazed at and above all to be touched in order to appreciate to the full its soft material quality.

Une matière cosmopolite qui transforme en sujet actif tout espace qu'elle décore et qui accompagne le vécu de ses habitants en créant un sentiment d'harmonie et de complicité. **Artifact** s'inspire de l'esprit simple du ciment spatulé obtenu artisanalement par des mains expertes, où la valeur de l'unicité devient un signe distinctif, un facteur d'identité qui dévoile le goût de ceux qui la choisissent pour leur quotidien. L'esthétique et la fonctionnalité se rencontrent pour former un style éclairé qui révèle une modernité inattendue. En tant que choix déclaré, l'imperfection exprime le désir de combiner la technologie et l'artisanat, la précision technique et l'imagination sans oublier le goût pour l'expérimentation. Une trame légère et délicate à regarder mais surtout à caresser pour en saisir pleinement la douceur de sa matière.

Ein kosmopolitisches Material, das jeden Raum in ein aktives Subjekt verwandelt und die Bewohner dieser Räumlichkeiten durch ein Gefühl der Harmonie und Komplizenschaft in ihrem Alltag unterstützt. **Artifact** erinnert an den einfachen Stil von Spachtelbeton, der von erfahrenen Händen von Hand hergestellt wird. Hier verwandelt sich seine Einzigartigkeit in ein unverwechselbares Kennzeichen, das den Geschmack derjenigen offenbart, die ihn für ihren Alltag wählen. Ästhetik und Funktionalität vereinen sich in einem aufgeklärten Stil, der eine unerwartete Modernität freisetzt. Unvollkommenheit als erklärte Wahl drückt den Wunsch aus, Technologie und Handwerk, technische Präzision und Phantasie zu verbinden, ohne die Experimentierfreude dabei zu vergessen. Eine leichte und zarte Textur, die es zu betrachten und vor allem zu berühren gilt, um ihre weiche materialbetonte Beschaffenheit vollständig wahrnehmen zu können.

Una materia cosmopolita que transforma en objeto activo todos los espacios en los que se propone y se adapta a las vivencias de quienes los habitan creando un sentimiento de armonía y complicidad. **Artifact** evoca el estilo sencillo del cemento espatulado, obtenido artesanalmente por manos maestras, en el que el valor de la singularidad se convierte en un signo distintivo y en un factor de identidad que desvela el gusto de quienes la eligen para su día a día. Estética y funcionalidad se funden en un estilo iluminado que libera una modernidad inesperada. La imperfección como elección declarada expresa el deseo de combinar tecnología y artesanía, precisión técnica e imaginación sin olvidar el gusto por la experimentación. Una textura ligera y delicada para admirarla pero sobre todo para acariciarla y percibir por completo su suave materialidad.

ARTIFACT

AGED_WHITE



WORN_SAND

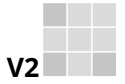
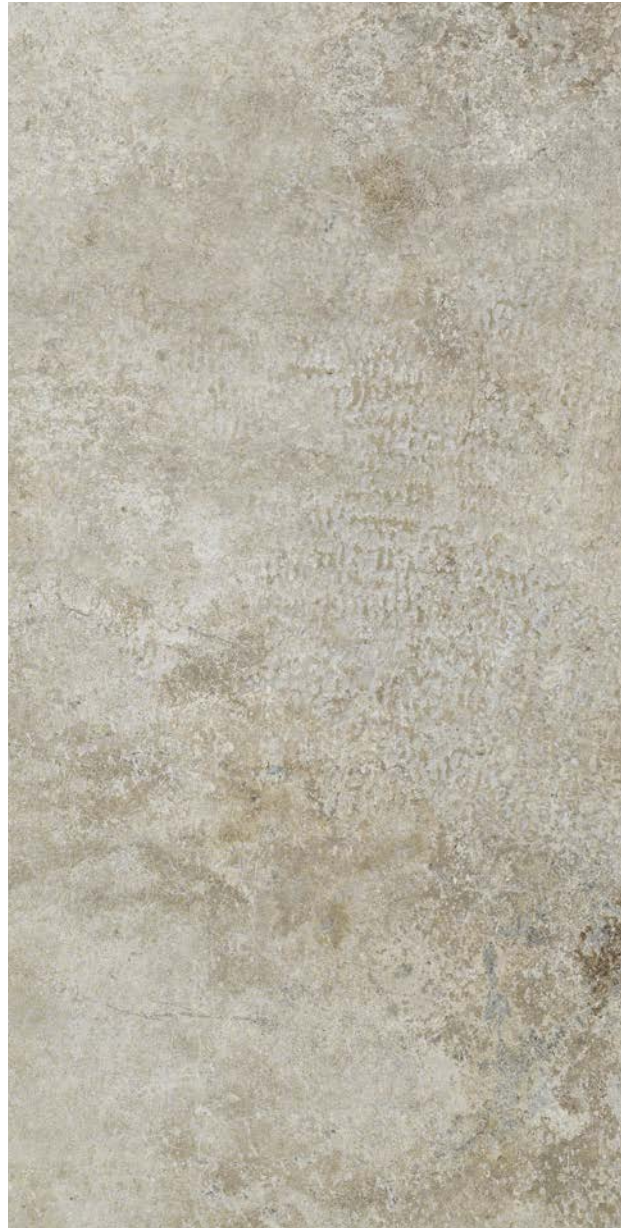

V2

R10
Classe B
(naturelle)



R12
Classe C
(grip)

DCOF>
0,42 Wet

9 mm 3/8" ↑↓

GRES PORCELLANATO SMALTATO

GLAZED PORCELAIN STONEWARE / GRES CÉRAMÉ ÉMAILLÉ / GLASIERTE FEINSTEINZEUG / GRES PORCELÁNICO ESMALTADO
SQUADRATO - SQUARED - EQUARRI - REKTIFIZIERT - ESCUADRADO

9 mm 3/8" ↑↓		COLOR	SURFACE	60x120 23 ^{5/8} "x47 ^{1/4} "	80x80 31 ^{1/2} "x31 ^{1/2} "	60x60 23 ^{5/8} "x23 ^{5/8} "	30x60 11 ^{4/5} "x23 ^{5/8} "
ARTIFACT		AGED_WHITE	NATURALE	760603 ■ FL-06700	760615 ■ FL-06400	760621 ■ FL-04600	760627 ■ FL-03800
			GRIP	-	-	-	760634 ■ FL-03800
		WORN_SAND	NATURALE	760604 ■ FL-06700	760616 ■ FL-06400	760622 ■ FL-04600	760628 ■ FL-03800
			GRIP	-	-	-	760635 ■ FL-03800

USED_GREY

VINTAGE_TAUPE

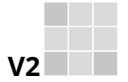

V2
R10
Classe B
 (naturele)

R12
Classe C
 (grip)

DCOF >
 0,42 Wet

9 mm 3/8" ↑↓

GRES PORCELLANATO SMALTATO

GLAZED PORCELAIN STONEWARE / GRES CÉRAME ÉMAILLÉ / GLASIERTE FEINSTEINZEUG / GRES PORCELÁNICO ESMALTADO
 SQUADRATO - SQUARED - EQUARRI - REKTIFIZIERT - ESCUADRADO

9 mm 3/8" ↑↓		COLOR	SURFACE	60x120 23 ^{5/8} "x47 ^{1/4} "	80x80 31 ^{1/2} "x31 ^{1/2} "	60x60 23 ^{5/8} "x23 ^{5/8} "	30x60 11 ^{4/5} "x23 ^{5/8} "
ARTIFACT	USED_GREY	NATURALE		760605 ■ FL-06700	760617 ■ FL-06400	760623 ■ FL-04600	760629 ■ FL-03800
		GRIP		-	-	-	760636 ■ FL-03800
	VINTAGE_TAUPE	NATURALE		760607 ■ FL-06700	760619 ■ FL-06400	760625 ■ FL-04600	760631 ■ FL-03800
		GRIP		-	-	-	760638 ■ FL-03800

ARTIFACT

WORKED_CHARCOAL

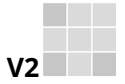

V2

R10
Classe B
(naturele)

R12
Classe C
(grip)

DCOF>
0,42 Wet

9 mm 3/8"

GRES PORCELLANATO SMALTATO

GLAZED PORCELAIN STONEWARE / GRES CÉRAMÉ ÉMAILLÉ / GLASIERTE FEINSTEINZEUG / GRES PORCÉLANICO ESMALTADO
SQUADRATO - SQUARED - EQUARRI - REKTIFIZIERT - ESCUADRADO

9 mm 3/8"	COLOR	SURFACE	60x120	80x80	60x60	30x60
			23 ⁵ / ₈ "x47 ¹ / ₄ "	31 ¹ / ₂ "x31 ¹ / ₂ "	23 ⁵ / ₈ "x23 ⁵ / ₈ "	11 ⁴ / ₅ "x23 ⁵ / ₈ "
ARTIFACT	 WORKED_CHARCOAL	NATURALE	760608 ■ FL-06700	760620 ■ FL-06400	760626 ■ FL-04600	760632 ■ FL-03800
		GRIP	-	-	-	760639 ■ FL-03800

9 mm 3/8" ↑↓		COLOR	SURFACE	30x30 11 4/5" x 11 4/5" mosaico tessere 3x3 pz/box 11	30x30 11 4/5" x 11 4/5" mosaico 3D 5x5 pz/box 8	21x40 8 1/4" x 15 3/4" modulo listello sfalsato	0,5x60 1/4" x 23 5/8" matita inox pz/box 4
	AGED_WHITE	NATURALE	760908 ▲ FL-01600	760909 ▲ FL-01900	760906 ■ FL-17200		719674 ▲ FL-03100
	WORN_SAND	NATURALE	760919 ▲ FL-01600	760929 ▲ FL-01900	760924 ■ FL-17200		
ARTIFACT	USED_GREY	NATURALE	760920 ▲ FL-01600	760930 ▲ FL-01900	760925 ■ FL-17200		
	VINTAGE_TAUPE	NATURALE	760922 ▲ FL-01600	760932 ▲ FL-01900	760927 ■ FL-17200		
	WORKED_CHARCOAL	NATURALE	760923 ▲ FL-01600	760933 ▲ FL-01900	760928 ■ FL-17200		

PEZZI SPECIALI/SPECIAL TRIMS/PIÈCES SPÉCIALES/FORMSTÜCKE/PIEZAS ESPECIALES

9 mm 3/8" ↑↓		COLOR	SURFACE	4,6x60 1 4/5" x 23 5/8" battiscopa
	AGED_WHITE	NATURALE	760911 ◆ FL-01600	
	WORN_SAND	NATURALE	760914 ◆ FL-01600	
ARTIFACT	USED_GREY	NATURALE	760915 ◆ FL-01600	
	VINTAGE_TAUPE	NATURALE	760917 ◆ FL-01600	
	WORKED_CHARCOAL	NATURALE	760918 ◆ FL-01600	



3D: Si consiglia la posa con stucco epossidico per ambienti bagnati o sottoposti a forte umidità. / 3D: We recommend laying with epoxy putty for wet environments or those subject to strong humidity. / 3D: pose conseillée avec mortier époxy pour environnements très humides ou mouillés. / 3D: In nassen oder starker Feuchtigkeit ausgesetzten Bereichen empfiehlt sich die Verlegung mit Epoxidstuck. / 3D: En ambientes mojados o muy húmedos, se recomienda realizar la colocación con estuco epoxidico.

Per un effetto ottimale della posa, florim suggerisce di mantenere 2 mm di fuga per pose monoformato e 3 mm per combinare formati misti. - For optimal installation results, florim recommends maintaining a joint of 2 mm 1/12" for single format installations and 3 mm 1/8" to combine mixed formats. - Pour réaliser une pose parfaite, florim suggère de maintenir 2 mm de joint pour la pose des monoformats, et 3 mm pour les combinaisons de formats mixtes. - Um einen optimalen effekt beim verlegen zu erzielen empfiehlt florim eine 2 mm fuge bei einformatigen verlegungen und 3 mm fuge bei formatkombinationen. Para lograr los máximos resultados en la posa del producto, florim aconseja 2 mm de junta en aplicaciones monoformato y 3 mm en combinaciones de formatos mixtos.

ARTIFACT	scatola - box			pallet		
	pz	mq	kg	box	mq	kg
60x120	2	1,44	28,08	30	43,20	870
80x80	2	1,28	24,96	40	51,20	1030
60x60	3	1,08	21,06	40	43,20	870
30x60	6	1,08	20,84	40	43,20	860
21x40 mod. list.sfals.	5	0,42	9,66	40	16,80	420

ARTIFACT	scatola - box			pallet		
	pz	ml	kg	box	mq	kg
4,6x60 battiscopa	14	8,40	8,40	-	-	-

ARTIFACT OUTDOOR

Vantaggi tecnici - Technical advantages - Avantages techniques Technische Vorteile - Ventajas técnicas

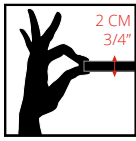

- Lastra monolitica compatta di spessore 2 cm squadrata e rettificata
- Compact monolithic slab 2 cm thick squared and rectified
- Dalle monolithique compacte de 2 cm d'épaisseur, égarrie et rectifiée
- Kompakte monolithische Platte, 2 cm dick, rechteckig und scharfkantig geschliffen
- Losa monolítica compacta de 2 cm de espesor, esquadrada y rectificada.

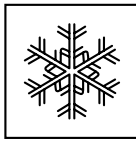

- INGELIVO
- FROST RESISTANT
- INGÉLIF
- FROSTBESTÄNDIG
- RESISTENTE A LA HELADA

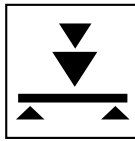

- ELEVATA RESISTENZA AI CARICHI STATICI
- HIGH STATIC LOAD RESISTANCE
- RÉSISTANCE ÉLEVÉE AUX CHARGES STATIQUES
- HOHE STATISCHE BELASTBARKEIT
- ELEVADA RESISTENCIA A LAS CARGAS ESTÁTICAS

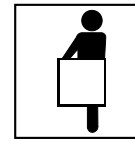

- FACILE DA POSARE
- EASY TO INSTALL
- FACILE À POSER
- VERLEGELEICHT
- FÁCIL DE COLOCAR



- ANTISCIVOLO R11
- ANTI SLIP R11
- ANTIDÉRAPANT R11
- RUTSCHFEST R11
- ANTIDESLIZANTE R11

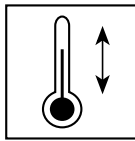

- RESISTENTE AGLI SBALZI TERMICI
- THERMAL SHOCK RESISTANT
- RÉSISTANT AUX ÉCARTS THERMIQUES
- TEMPERATURWECHSELBESTÄNDIG
- RESISTENTE A LAS OSCILACIONES TÉRMICAS



- FACILE DA PULIRE
- EASY TO CLEAN
- FACILE À NETTOYER
- REINIGUNGSLEICHT
- FÁCIL DE LIMPIAR

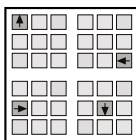

- RIMOVIBILE E RIUTILIZZABILE
- REMOVABLE AND REUSABLE
- DÉMONTABLE ET RÉUTILISABLE
- ENTFERNBAR UND WIEDERVERWENDBAR
- DESMONTABLE Y REUTILIZABLE

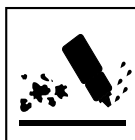

- INATTACCABILE DA AGENTI CHIMICI E MUFFE
- IMPERVIOUS TO ATTACK BY CHEMICALS OR MOULD
- RÉSISTANT AUX AGENTS CHIMIQUES ET AUX MOISSISSURES
- UNANGREIFBAR DURCH CHEMISCHE STOFFE UND SCHIMMEL
- RESISTENTE A LOS AGENTES QUÍMICOS Y A LOS MOHOS

Applicazioni - Applications - Applications - Verlegung - Aplicaciones

- Posa diretta su erba
- Direct installation on grass
- Pose direct sur de l'herbe
- Verlegung direkt auf Rasen
- Colocación directa sobre hierba



- Posa diretta su ghiaia
- Direct installation over gravel
- Pose direct sur du gravier
- Verlegung direkt auf Kies
- Colocación directa sobre grava



- Posa su massetto cementizio
- Installation on sand-cement screed
- Pose sur chape ciment
- Verlegung auf Zement-Unterbetonblock
- Colocación sobre contrapiso de hormigón

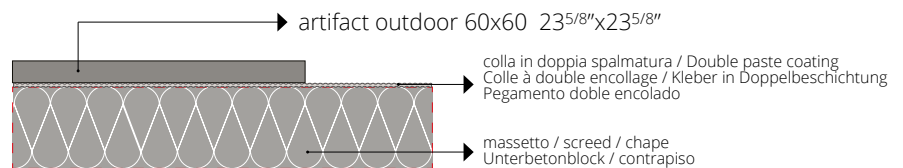

- Posa su piedini fissi o regolabili
- Installation on fixed or adjustable feet
- Pose sur pieds fixes ou réglables
- Verlegung auf feststehende oder regulierbare Füße
- Colocación sobre pies fijos o regulables

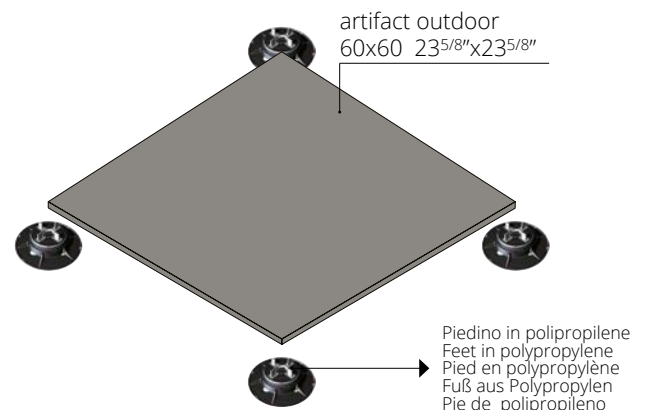

Per le specifiche di utilizzo dei sistemi sopraelevati vedi il sito florim.com
For the specifics on use of raised systems visit the site florim.com
Pour les caractéristiques d'utilisation des systèmes surélevés, voir le site florim.com
Für die Nutzungsbedingungen der Doppelbodensysteme siehe Webseite florim.com
Para las especificaciones de empleo de los sistemas sobreelevados consulte el sitio web florim.com

Le lastre ceramiche sono sottoposte a un trattamento di compattazione termica che assicura resistenza e durata nel tempo. Il bassissimo assorbimento d'acqua rende perciò il materiale ingelivo. Ciò può comportare ristagni d'acqua superficiali anche per materiale installato a regola d'arte. / Ceramic tiles undergo a compacting thermal treatment that ensures resistance and durability. The low level of water absorption makes the slabs frost resistant. This could result in superficial water stagnations even if materials are installed in a workmanlike manner. / Les carreaux de céramique subissent un traitement thermique de compactage qui assure résistance et durabilité. Le bas niveau d'absorption d'eau rend les dalles résistant au gel. Il pourrait en résulter des stagnations d'eau superficielles, même si les dalles ont été installées dans les règles de l'art. / Die Keramikplatten werden einer thermischen Verdichtung unterzogen, welche die Widerstandsfähigkeit und Langlebigkeit sichert. Die extrem niedrige Wasseraufnahme macht das Material frostsicher. Die hohe Materialdichte kann, auch bei einer perfekten Verlegung, eine längere Abtrochnungszeit von angestaumtem Wasser zur Folge haben. / Las baldosas cerámicas se someten a un tratamiento de compactación térmica que asegura resistencia y durabilidad. La baja absorción de agua hace que las baldosas resistan al hielo. Esto podría resultar en estancamientos superficiales de agua, incluso si los materiales están instalados según las reglas del arte.

WORN_SAND

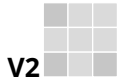

R11

20 mm 3/4" ↓

GRES FINE PORCELLANATO

FINE PORCELAIN STONEWARE/GRES CERAME FIN/FEINSTEINZEUG-KOLLEKTIONEN/GRES PORCELANICO FINO
SQUADRATO - SQUARED - EQUARRI - REKTIFIZIERT - ESCUADRADO

20 mm 3/4" ↓	COLOR	SURFACE	60x60 23 ^{5/8} "x23 ^{5/8} "
ARTIFACT	WORN_SAND	GRIP	762769 ■ FL-07300

	RESISTENZA ALLA FLESSIONE IN N/mm² N/mm ² FLEXURAL STRENGTH TEST / RESISTANCE A LA FLEXION EN N/mm ² / BIEGESTÄRKEIT IN N/mm ² / RESISTENCIA A LA FLEXION EN N/mm ² /	valore medio 52 N/mm²
	Forza di rottura in N (sp. > 7,5 mm) Breaking strength in N (thickness > 7,5 mm) / Force de rupture en N (ép. > 7,5 mm) / Bruchlast in N (Dicke > 7,5 mm) / Fuerza de rotura en N (gr. > 7,5 mm) /	valore medio 14000 N



PEZZI SPECIALI

Special trims/Pièces spéciales/Formstücke
Piezas especiales

pag 150/151

ARTIFACT	scatola - box			pallet		
	pz	mq	kg	box	mq	kg
60x60 20mm	2	0,72	32,15	30	21,60	990

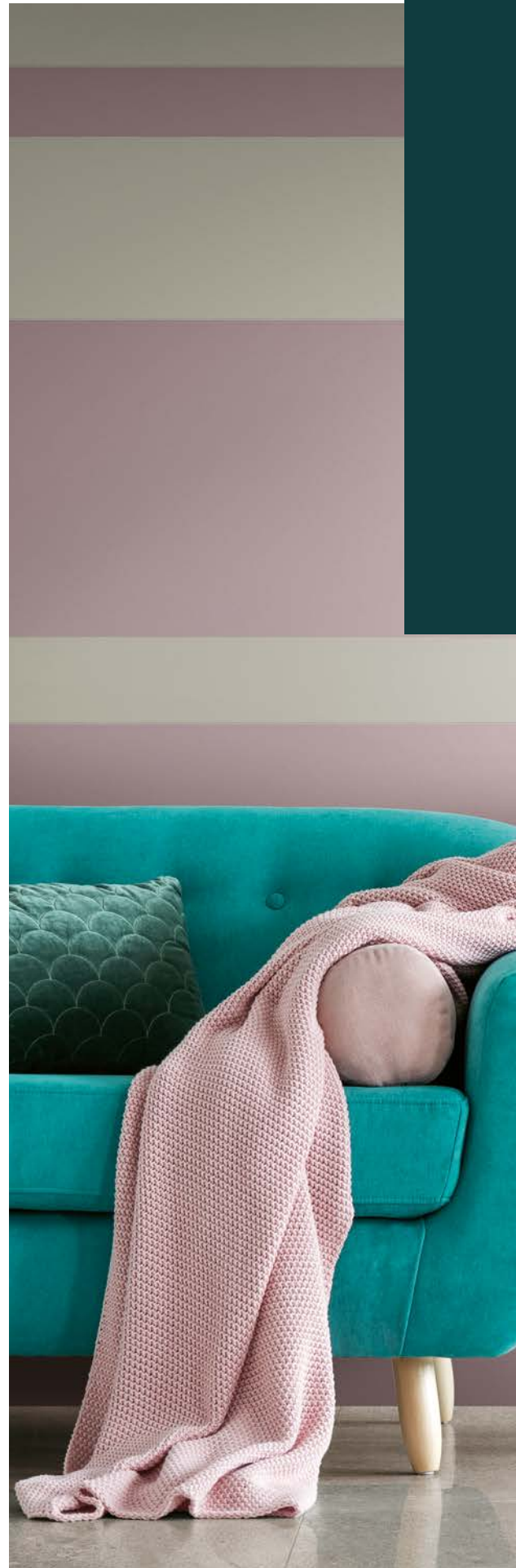

CRAYONS

gres fine porcellanato
fine porcelain stoneware
grès cérame fin
feinsteinzeug-kollektionen
gres porcelánico fino





CRAYONS

Crayons, il tema del colore approda anche al mondo delle superfici ceramiche in grande formato, otto tinte pastello pensate per dare vita a composizioni vivaci ed equilibrate, in armonia tra loro e con il contesto. Si passa dalle cromie polverose di chiara ispirazione anni Cinquanta del color latte, del tortora, del nocciola, del rosa, del giallo sbiadito e dell'azzurro cielo a quelle più decise del grigio polveroso e del verde muschio, tutte perfette per creare ambienti dallo stile retrò e dal carattere contemporaneo. Le superfici della collezione nascono sia per essere abbinata le une con le altre, sia per accompagnare le altre collezioni del brand.

Crayons, the world of large-size ceramic tiles welcomes colour: eight pastel shades designed to create vibrant and balanced compositions, in perfect accord with each other and with the surroundings. From dusty Fifties-inspired shades, such as milk, taupe, hazelnut, pink, straw and sky blue to bolder hues like dusty grey and moss green, all perfectly suited to creating environments with a retro vibe and a contemporary character. The surfaces in the collection may be combined together, as well as utilized in conjunction with the other collections by the same brand.

Crayons, le thème de la couleur aborde également le monde des surfaces céramiques grand format, huit teintes pastel conçues pour créer des compositions vives et équilibrées, en harmonie entre elles et avec le contexte. L'on passe ainsi des teintes poussiéreuses clairement inspirées par les années 50 comme les couleurs lait, tourterelle, noisette, rose, jaune fané et bleu ciel aux couleurs plus vives telles que gris poussiéreux et vert mousse, toutes parfaites pour créer des espaces au style rétro et au caractère contemporain. Les surfaces de la collection naissent ainsi pour se combiner les unes avec les autres mais aussi pour accompagner les autres collections de la marque.

Crayons, das Farbthema erreicht nun auch das Universum der Keramikoberflächen im Großformat mit acht Pastelltönen, die lebhaft und ausgewogene Zusammenstellungen ins Leben, ganz im Einklang untereinander und mit den Räumen. Die Palette reicht von den staubigen Farbtönen Milchweiß, Taubengrau, Haselnussbraun, Rosa, Blassgelb und Himmelblau, die eindeutig an die fünfziger Jahre erinnern, bis hin zu den kräftigeren Farben Staubgrau und Moosgrün, die sich alle für eine Raumgestaltung im zeitgenössischen Look und Retrostil perfekt eignen. Die Oberflächen der Kollektion können sowohl untereinander kombiniert als auch zusammen mit den anderen Kollektionen der Marke benutzt werden.

Crayons, el tema del color llega también al mundo de las superficies cerámicas en gran formato, ocho tonos pastel pensados para dar vida a composiciones vivaces y equilibradas, en armonía entre sí y con el contexto. Se pasa de los tonos polvorientos de clara inspiración años Cincuenta como el color leche, tórtola, avellana, rosa, amarillo claro y azul cielo a los más intensos del gris polvoriento y del verde musgo, todos perfectos para crear ambientes con un estilo retro y un carácter contemporáneo. Las superficies de la colección nacen para combinarse unas con otras y para acompañar a otras colecciones de la marca.

CRAYONS

MILK

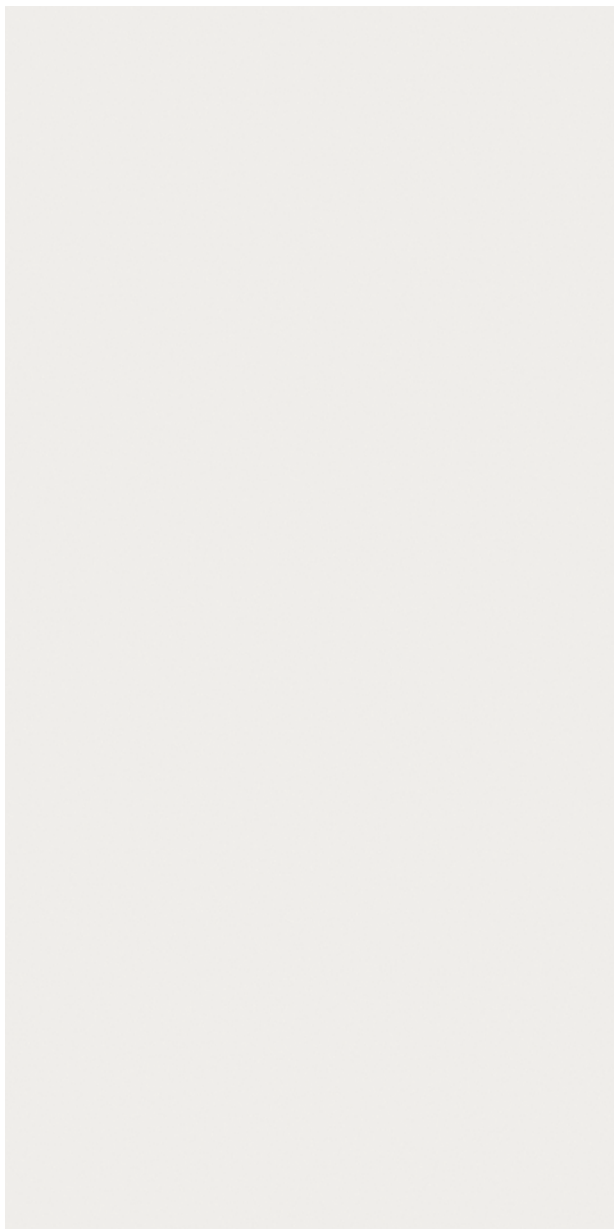

OLD LACE

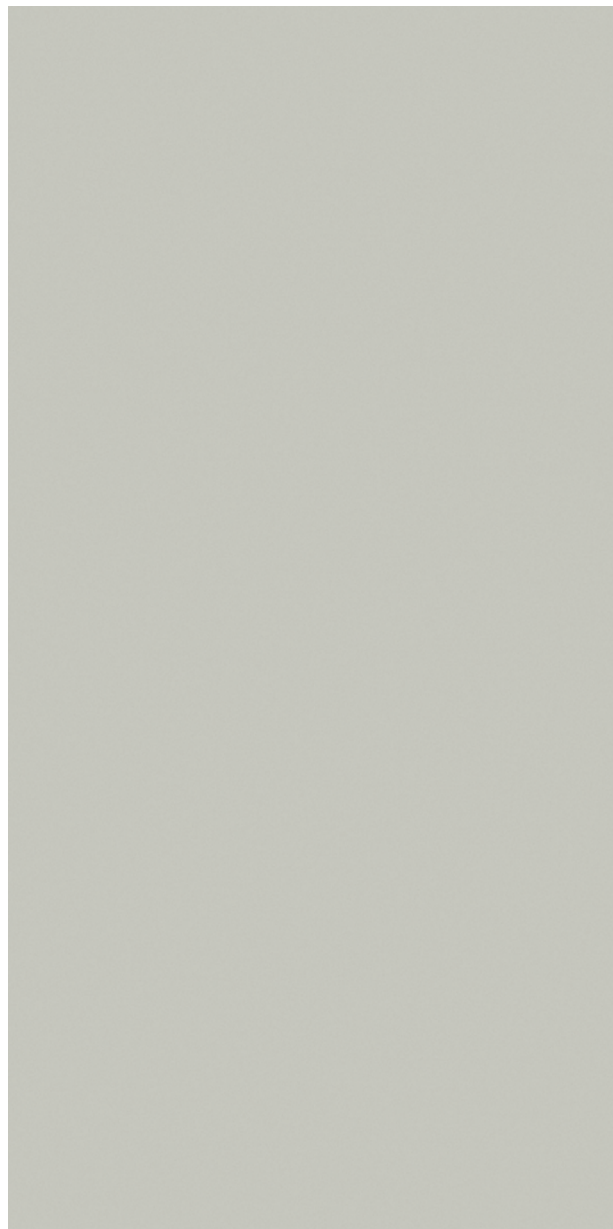

V1



R9

6 mm 1/4" ↑↓

FLORIM OVERSIZE
magnUm

GRES FINE PORCELLANATO

FINE PORCELAIN STONEWARE/GRES CERAME FIN/FEINSTEINZEUG-KOLLEKTIONEN/GRES PORCELANICO FINO
SQUADRATO - SQUARED - EQUARRI - REKTIFIZIERT - ESCUADRADO

6 mm 1/4" ↑↓		COLOR	SURFACE	120x240 47 ^{11/16} "x94 ^{1/2} "	120x120 47 ^{11/16} "x47 ^{11/16} "	60x120 23 ^{5/8} "x47 ^{11/16} "	40x120 15 ^{3/4} "x47 ^{11/16} "
CRAYONS		MILK	NATURALE	767797 ■ FL-08400	767798 ■ FL-07000	767799 ■ FL-06700	767800 ■ FL-06700
		OLD LACE	NATURALE	767235 ■ FL-08400	767249 ■ FL-07000	767263 ■ FL-06700	767742 ■ FL-06700

PRIMROSE

HAZELNUT

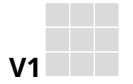

V1



R9

6 mm 1/4" ↑↓

FLOHM OVERSIZE
magnUm

GRES FINE PORCELLANATO

FINE PORCELAIN STONEWARE/GRES CERAME FIN/FEINSTEINZEUG-KOLLEKTIONEN/GRES PORCELANICO FINO
SQUADRATO - SQUARED - EQUARRI - REKTIFIZIERT - ESCUADRADO

6 mm 1/4" ↑↓		COLOR	SURFACE	120x240 47 ^{11/16"} x94 ^{1/2"}	120x120 47 ^{11/16"} x47 ^{1/16"}	60x120 23 ^{5/8"} x47 ^{1/16"}	40x120 15 ^{3/4"} x47 ^{1/16"}
CRAYONS		PRIMROSE	NATURALE	767236 ■ FL-08400	767250 ■ FL-07000	767264 ■ FL-06700	767743 ■ FL-06700
		HAZELNUT	NATURALE	767234 ■ FL-08400	767248 ■ FL-07000	767262 ■ FL-06700	767741 ■ FL-06700

CRAYONS

BUTTERCREAM



SKYLINE

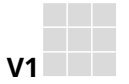
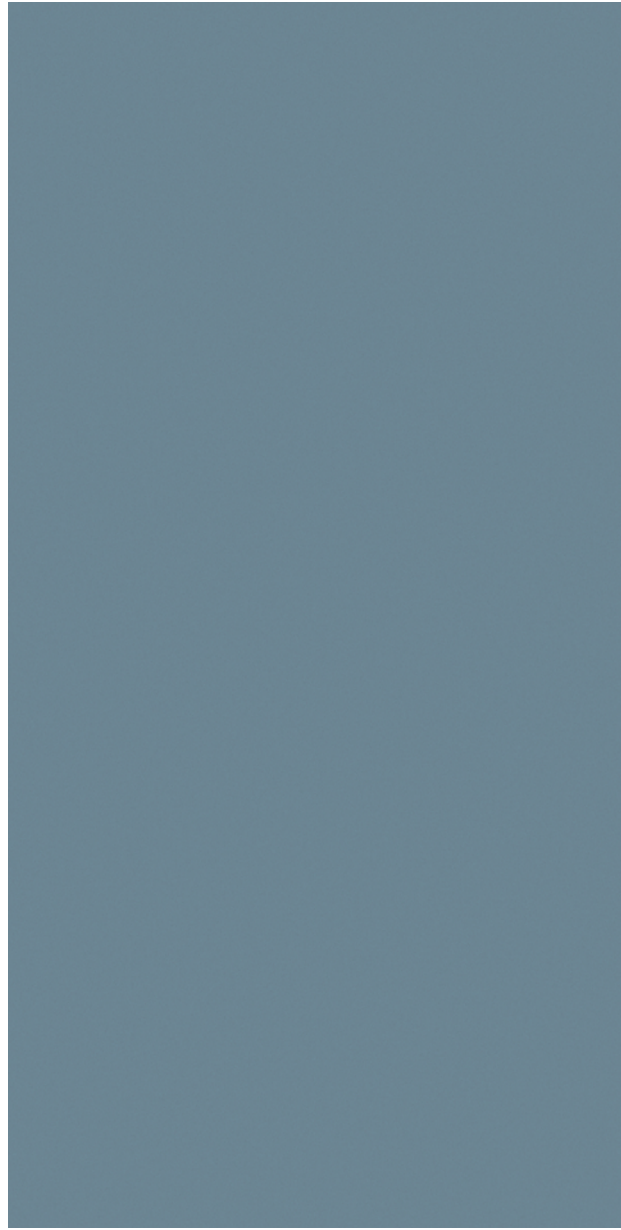



R9



GRES FINE PORCELLANATO

FINE PORCELAIN STONEWARE/GRES CERAME FIN/FEINSTEINZEUG-KOLLEKTIONEN/GRES PORCELANICO FINO
SQUADRATO - SQUARED - EQUARRI - REKTIFIZIERT - ESCUADRADO

6 mm 1/4" ↓↑		COLOR	SURFACE	120x240 47 ^{11/16} "x94 ^{1/2} "	120x120 47 ^{11/16} "x47 ^{11/16} "	60x120 23 ^{5/8} "x47 ^{11/16} "	40x120 15 ^{3/4} "x47 ^{11/16} "
CRAYONS		BUTTERCREAM	NATURALE	767237 ■ FL-08400	767251 ■ FL-07000	767265 ■ FL-06700	767744 ■ FL-06700
		SKYLINE	NATURALE	767238 ■ FL-08400	767252 ■ FL-07000	767266 ■ FL-06700	767745 ■ FL-06700

Per un effetto ottimale della posa, florim suggerisce di mantenere 2 mm di fuga per pose monoformato e 3 mm per combinare formati misti - For optimal installation results, florim recommends maintaining a joint of 2 mm 1/12" for single format installations and 3 mm 1/8" to combine mixed formats. - Pour réaliser une pose parfaite, florim suggère de maintenir 2 mm de joint pour la pose des monoformats, et 3 mm pour les combinaisons de formats mixtes. - Um einen optimalen effekt beim verlegen zu erzielen empfiehlt florim eine 2 mm fuge bei einformatigen verlegungen und 3 mm fuge bei formatkombinationen Para lograr los máximos resultados en la posa del producto, florim aconseja 2 mm de junta en aplicaciones monoformato y 3 mm en combinaciones de formatos mixtos.

MIST

MOSS

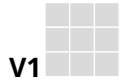

R9



GRES FINE PORCELLANATO

FINE PORCELAIN STONEWARE/GRES CERAME FIN/FEINSTEINZEUG-KOLLEKTIONEN/GRES PORCELANICO FINO
SQUADRATO - SQUARED - EQUARRI - REKTIFIZIERT - ESCUADRADO

6 mm 1/4" ↑↓	COLOR	SURFACE	120x240	120x120	60x120	40x120
			47 ^{11/16"} x94 ^{1/2"}	47 ^{11/16"} x47 ^{1/16"}	23 ^{5/8"} x47 ^{1/16"}	15 ^{3/4"} x47 ^{1/16"}
CRAYONS	MIST	NATURALE	767239 ■ FL-08400	767253 ■ FL-07000	767267 ■ FL-06700	767746 ■ FL-06700
	MOSS	NATURALE	767240 ■ FL-08400	767254 ■ FL-07000	767268 ■ FL-06700	767747 ■ FL-06700

CRAYONS	scatola - box			pallet		
	pz	mq	kg	box	mq	kg
40x120	6	2,88	41,70	17	48,96	730

FLOHM OVERSIZE
magnUm

120x240/120x120/60x120
Specifica Imballo pag.
Packaging specifications on page
Spécifications d'emballage à page
Verpackungsdetail Seite
Especificaciones de embalaje a la página
158/159



ELEMENTAL STONE

gres porcellanato smaltato
glazed porcelain stoneware
gres cérame émaillé
glasierte Feinsteinzeug
gres Porcelánico esmaltado





ELEMENTAL STONE

Importante integrazione della gamma di superfici ispirate al mondo delle pietre Contemporary design, **Elemental Stone** propone superfici ispirate a rocce sedimentarie dal carattere semplice e dall'estetica poliedrica, composte da granuli ed elementi calcarei dalla diversa tessitura e declinate in tre cromie, perfettamente in linea con il gusto contemporaneo del marchio. Tonalità neutre contribuiscono a creare un'atmosfera contemporanea all'interno dello spazio, difficilmente soggetta al passare delle mode. L'aspetto minimale delle superfici, a seconda della finitura e della combinazione con l'arredo, può dar vita ad ambienti dallo stile differente, per incontrare un gusto classico o dai caratteri più trendy, adattandosi perfettamente ad ogni scelta personale.

An important addition to the range of Contemporary design surfaces inspired by the world of stones, **Elemental Stone** offers surfaces inspired by sedimentary rocks. Simple in character and featuring polyhedral aesthetics, they are composed of granules and limestone elements with varying textures and are available in three colours, perfectly in line with the brand's contemporary flavour. Neutral shades help to create a contemporary feel within the space, which is not affected by passing trends. The minimal look of the surfaces can, depending on the finish and the combination with the furniture, give life to environments with different styles, from a classic feel to a trendy vibe, perfectly adapting to suit your personal choices.

Importante intégration de la gamme de surfaces inspirées du monde des pierres de Contemporary design, **Elemental Stone** propose des surfaces inspirées des roches sédimentaires au caractère simple et à l'esthétique polyédrique, composées de granulés et d'éléments calcaires à la texture différente et déclinées dans trois couleurs, en parfaite adéquation avec le goût contemporain de la marque. Des tonalités neutres contribuent à créer, à l'intérieur de l'espace, une atmosphère contemporaine difficilement soumise à l'évolution des modes. L'aspect minimal des surfaces, selon la finition et la combinaison avec le mobilier, peut donner naissance à des environnements au style différent, pour rencontrer un goût classique ou plus à la mode, en s'adaptant à la perfection à chaque choix personnel.

Elemental Stone stellt eine bedeutende Ergänzung zur Produktpalette von Oberflächen dar, deren Inspirationsquelle das Werksteinuniversum von Contemporary design ist. Es bietet Oberflächen an, die von einfachen und vielseitig gestalteten Sedimentgesteinen inspiriert sind, bestehend aus Kalksteinelementen und -körnern verschiedener Texturen und in drei Farben, die ganz im Einklang mit dem zeitgenössischen Geschmack der Marke stehen. Neutrale Farbtöne tragen dazu bei, eine moderne und immerfort aktuelle Raumatmosphäre zu schaffen. Der Minimal Look der Oberflächen kann je nach Finish und Einrichtungskombination Räume mit stets unterschiedlichen Stilrichtungen herbeizaubern, um einen klassischen oder modebewussteren Geschmack zufriedenzustellen und sich dabei problemlos jeder persönlichen Wahl anzupassen.

Importante integración de la gama de superficies inspiradas en el mundo de las piedras de Contemporary design, **Elemental Stone** propone superficies inspiradas en rocas sedimentarias con un carácter sencillo y una estética poliédrica, compuestas por gránulos y elementos calcáreos con una textura distinta y propuestas en tres tonos, perfectamente en línea con el gusto contemporáneo de la marca. Tonos neutros ayudan a crear una atmósfera contemporánea dentro del espacio, difícilmente sujeta al paso de las modas. El aspecto minimalista de las superficies, en función del acabado y de la combinación con la decoración, puede dar vida a ambientes con un estilo diferente, para encontrar un gusto clásico o con toques más de tendencia, adaptándose perfectamente a cada elección personal.

ELEMENTAL STONE

WHITE SANDSTONE



WHITE LIMESTONE

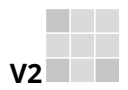

V2
R10
Classe B
(naturale)

R11
Classe B
(grip)

DCOF>
0,42 Wet

9 mm 3/8" ↑↓

GRES PORCELLANATO SMALTATO

GLAZED PORCELAIN STONEWARE / GRES CÉRAMÉ ÉMAILLÉ / GLASIERTE FEINSTEINZEUG / GRES PORCÉLANICO ESMALTADO

SQUADRATO - SQUARED - EQUARRI - REKTIFIZIERT - ESCUADRADO

9 mm 3/8" ↑↓	COLOR	SURFACE	60x120 23 ^{5/8"} x47 ^{1/4"}	60x60 23 ^{5/8"} x23 ^{5/8"}	30x60 11 ^{4/8"} x23 ^{5/8"}
ELEMENTAL STONE	WHITE SANDSTONE	NATURALE	766501 ■ FL-06700	766940 ■ FL-05100	766608 ■ FL-04400
		LUCIDO	766506 ■ FL-08100	766939 ■ FL-06500	766621 ■ FL-05500
		GRIP	-	-	766618 ■ FL-04400
	WHITE LIMESTONE	NATURALE	766509 ■ FL-06700	766941 ■ FL-05100	766609 ■ FL-04400
		LUCIDO	766510 ■ FL-08100	766949 ■ FL-06500	766622 ■ FL-05500

WHITE DOLOMIA

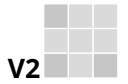

V2

R10
Classe B
(naturale)

DCOF>
0,42 Wet

9 mm 3/8" ↑↓

GRES PORCELLANATO SMALTATO

GLAZED PORCELAIN STONEWARE / GRES CÉRAMÉ ÉMAILLÉ / GLASIERTE FEINSTEINZEUG / GRES PORCÉLANICO ESMALTADO
SQUADRATO - SQUARED - EQUARRI - REKTIFIZIERT - ESCUADRADO

9 mm 3/8" ↑↓		COLOR	SURFACE	60x120 23 ^{5/8"} x47 ^{1/4"}	60x60 23 ^{5/8"} x23 ^{5/8"}	30x60 11 ^{4/5"} x23 ^{5/8"}
ELEMENTAL STONE		WHITE DOLOMIA	NATURALE	766512 ■ FL-06700	766942 ■ FL-05100	766610 ■ FL-04400
			LUCIDO	766513 ■ FL-08100	766950 ■ FL-06500	766623 ■ FL-05500

ELEMENTAL STONE

CREAM SANDSTONE



CREAM LIMESTONE



V2

R10
Classe B
(naturale)

R11
Classe B
(grip)

DCOF>
0,42 Wet

9 mm 3/8" ↑↓

GRES PORCELLANATO SMALTATO

GLAZED PORCELAIN STONEWARE / GRES CÉRAME ÉMAILLÉ / GLASIERTE FEINSTEINZEUG / GRES PORCELÁNICO ESMALTADO

SQUADRATO - SQUARED - EQUARRI - REKTIFIZIERT - ESCUADRADO

9 mm 3/8" ↑↓	COLOR	SURFACE	60x120 23 ^{5/8"} x47 ^{1/4"}	60x60 23 ^{5/8"} x23 ^{5/8"}	30x60 11 ^{4/5"} x23 ^{5/8"}
ELEMENTAL STONE	CREAM SANDSTONE	NATURALE	766514 ■ FL-06700	766943 ■ FL-05100	766611 ■ FL-04400
		LUCIDO	766515 ■ FL-08100	766951 ■ FL-06500	766624 ■ FL-05500
		GRIP	-	-	766619 ■ FL-04400
	CREAM LIMESTONE	NATURALE	766516 ■ FL-06700	766944 ■ FL-05100	766613 ■ FL-04400
		LUCIDO	766517 ■ FL-08100	766952 ■ FL-06500	766625 ■ FL-05500

CREAM DOLOMIA

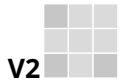

V2

R10
Classe B
(naturale)

DCOF>
0,42 Wet

9 mm 3/8" ↑↓

GRES PORCELLANATO SMALTATO

GLAZED PORCELAIN STONEWARE / GRES CÉRAMÉ ÉMAILLÉ / GLASIERTE FEINSTEINZEUG / GRES PORCÉLANICO ESMALTADO
SQUADRATO - SQUARED - EQUARRI - REKTIFIZIERT - ESCUADRADO

9 mm 3/8" ↑↓		COLOR	SURFACE	60x120 23 ^{5/8"} x47 ^{1/4"}	60x60 23 ^{5/8"} x23 ^{5/8"}	30x60 11 ^{4/5"} x23 ^{5/8"}
ELEMENTAL STONE		CREAM DOLOMIA	NATURALE	766518 ■ FL-06700	766945 ■ FL-05100	766614 ■ FL-04400
			LUCIDO	766519 ■ FL-08100	766953 ■ FL-06500	766626 ■ FL-05500

ELEMENTAL STONE

GREY SANDSTONE

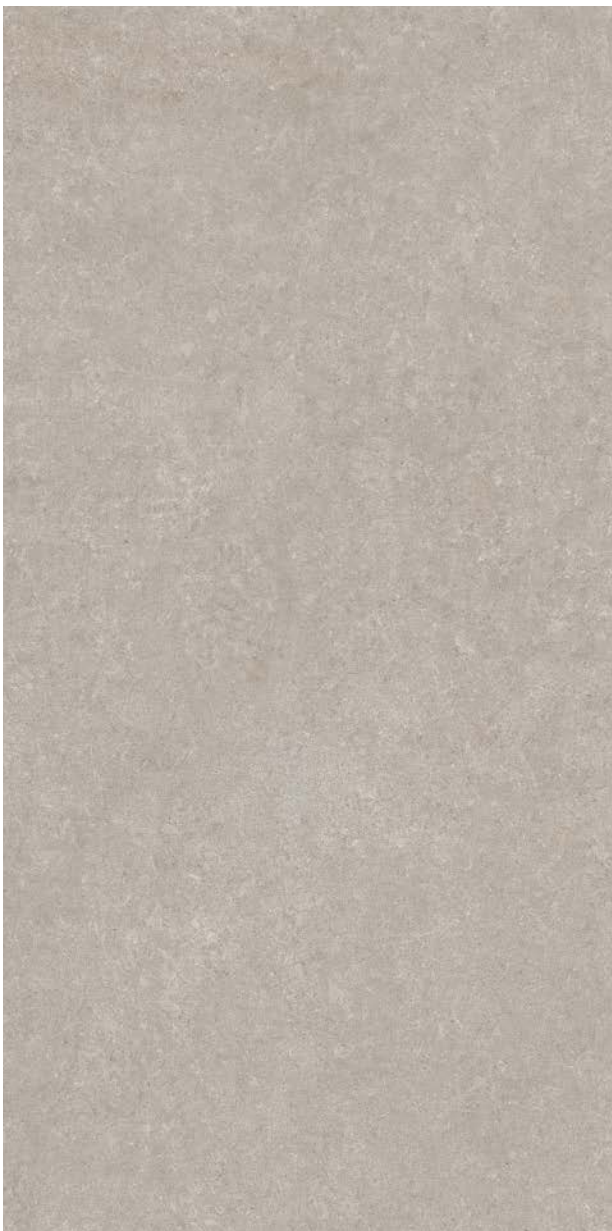

GREY LIMESTONE



R10
Classe B
(naturale)

R11
Classe B
(grip)

DCOF>
0,42 Wet

9 mm 3/8" ↑↓

GRES PORCELLANATO SMALTATO

GLAZED PORCELAIN STONEWARE / GRES CÉRAMÉ ÉMAILLÉ / GLASIERTE FEINSTEINZEUG / GRES PORCELÁNICO ESMALTADO

SQUADRATO - SQUARED - EQUARRI - REKTIFIZIERT - ESCUADRADO

9 mm 3/8" ↑↓	COLOR	SURFACE	60x120 23 ^{5/8"} x47 ^{1/4"}	60x60 23 ^{5/8"} x23 ^{5/8"}	30x60 11 ^{4/5"} x23 ^{5/8"}
ELEMENTAL STONE	GREY SANDSTONE	NATURALE	766520 ■ FL-06700	766946 ■ FL-05100	766615 ■ FL-04400
		LUCIDO	766521 ■ FL-08100	766954 ■ FL-06500	766628 ■ FL-05500
		GRIP	-	-	766620 ■ FL-04400
	GREY LIMESTONE	NATURALE	766522 ■ FL-06700	766947 ■ FL-05100	766616 ■ FL-04400
		LUCIDO	766524 ■ FL-08100	766955 ■ FL-06500	766629 ■ FL-05500

GREY DOLOMIA

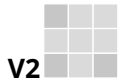

V2

R10
Classe B
(naturale)

DCOF >
0,42 Wet

9 mm 3/8" ↑↓









GRES PORCELLANATO SMALTATO

GLAZED PORCELAIN STONEWARE / GRES CÉRAMÉ ÉMAILLÉ / GLASIERTE FEINSTEINZEUG / GRES PORCÉLANICO ESMALTADO
SQUADRATO - SQUARED - EQUARRI - REKTIFIZIERT - ESCUADRADO

9 mm 3/8" ↑↓		COLOR	SURFACE	60x120 23 ^{5/8"} x47 ^{1/4"}	60x60 23 ^{5/8"} x23 ^{5/8"}	30x60 11 ^{4/5"} x23 ^{5/8"}
ELEMENTAL STONE		GREY DOLOMIA	NATURALE	766526 ■ FL-06700	766948 ■ FL-05100	766617 ■ FL-04400
			LUCIDO	766528 ■ FL-08100	766956 ■ FL-06500	766630 ■ FL-05500

ELEMENTAL STONE

9 mm 3/8" ↑↓

	COLOR	SURFACE	30x30 11 4/5" x 11 4/5"  mosaico tessere 3x3 pz/box 11	30x30 11 4/5" x 11 4/5"  mosaico 3D tessere 5x30 pz/box 8	15x60 6" x 23 5/8"  modulo listello sfalsato mix naturale/lucido pz/box 6	0,5x60 1/4" x 23 5/8" matita inox pz/box 4
	WHITE SANDSTONE	NATURALE	767026 ▲ FL-01600	767167 ▲ FL-02000	767024 ▲ FL-03100	719674 ▲ FL-03100
		LUCIDO	767029 ▲ FL-01600	767168 ▲ FL-02300		
	WHITE LIMESTONE	NATURALE	767030 ▲ FL-01600	767169 ▲ FL-02000	767025 ▲ FL-03100	
		LUCIDO	767031 ▲ FL-01600	767170 ▲ FL-02300		
	WHITE DOLOMIA	NATURALE	767032 ▲ FL-01600	767171 ▲ FL-02000	767027 ▲ FL-03100	
		LUCIDO	767033 ▲ FL-01600	767172 ▲ FL-02300		
	CREAM SANDSTONE	NATURALE	767034 ▲ FL-01600	760173 ▲ FL-02000	767028 ▲ FL-03100	
		LUCIDO	767148 ▲ FL-01600	767174 ▲ FL-02300		
ELEMENTAL STONE 	CREAM LIMESTONE	NATURALE	767147 ▲ FL-01600	760175 ▲ FL-02000	767035 ▲ FL-03100	
		LUCIDO	767149 ▲ FL-01600	767176 ▲ FL-02300		
	CREAM DOLOMIA	NATURALE	767150 ▲ FL-01600	760184 ▲ FL-02000	767036 ▲ FL-03100	
		LUCIDO	767151 ▲ FL-01600	767186 ▲ FL-02300		
	GREY SANDSTONE	NATURALE	767152 ▲ FL-01600	760188 ▲ FL-02000	767037 ▲ FL-03100	
		LUCIDO	767153 ▲ FL-01600	767189 ▲ FL-02300		
	GREY LIMESTONE	NATURALE	767154 ▲ FL-01600	760191 ▲ FL-02000	767038 ▲ FL-03100	
		LUCIDO	767155 ▲ FL-01600	767192 ▲ FL-02300		
	GREY DOLOMIA	NATURALE	767156 ▲ FL-01600	760194 ▲ FL-02000	767039 ▲ FL-03100	
		LUCIDO	767157 ▲ FL-01600	767196 ▲ FL-02300		

PEZZI SPECIALI/SPECIAL TRIMS/PIÈCES SPÉCIALES/FORMSTÜCKE/PIEZAS ESPECIALES

9 mm 3/8" ↑↓

4,6x60
1 4/5" x 2 3/8"



battiscopa

ELEMENTAL STONE

COLOR	SURFACE	767177 ◆ FL-01600
	NATURALE	767177 ◆ FL-01600
	LUCIDO	767178 ◆ FL-01600
	NATURALE	767179 ◆ FL-01600
	LUCIDO	767181 ◆ FL-01600
	NATURALE	767180 ◆ FL-01600
	LUCIDO	767182 ◆ FL-01600
	NATURALE	767187 ◆ FL-01600
	LUCIDO	767195 ◆ FL-01600
	NATURALE	767190 ◆ FL-01600
	LUCIDO	767197 ◆ FL-01600
	NATURALE	767193 ◆ FL-01600
	LUCIDO	767198 ◆ FL-01600
	NATURALE	767199 ◆ FL-01600
	LUCIDO	767200 ◆ FL-01600
	NATURALE	767201 ◆ FL-01600
	LUCIDO	767202 ◆ FL-01600
	NATURALE	767205 ◆ FL-01600
	LUCIDO	767206 ◆ FL-01600

Product Certification
BUREAU VERITAS
Certification

Recycled material content certification



3D: Si consiglia la posa con stucco epossidico per ambienti bagnati o sottoposti a forte umidità. / 3D: We recommend laying with epoxy putty for wet environments or those subject to strong humidity. / 3D: pose conseillée avec mortier époxy pour environnements très humides ou mouillés. / 3D: In nassen oder starker Feuchtigkeit ausgesetzten Bereichen empfiehlt sich die Verlegung mit Epoxidstuck. / 3D: En ambientes mojados o muy húmedos, se recomienda realizar la colocación con estuco epoxidico.

Per un effetto ottimale della posa, florim suggerisce di mantenere 2 mm di fuga per pose monoformato e 3 mm per combinare formati misti. - For optimal installation results, florim recommends maintaining a joint of 2 mm 1/12" for single format installations and 3 mm 1/8" to combine mixed formats. - Pour réaliser une pose parfaite, florim suggère de maintenir 2 mm de joint pour la pose des monoformats, et 3 mm pour les combinaisons de formats mixtes. - Um einen optimalen effekt beim verlegen zu erzielen empfiehlt florim eine 2 mm fuge bei einformatigen verlegungen und 3 mm fuge bei formatkombinationen Para lograr los máximos resultados en la posa del producto, florim aconseja 2 mm de junta en aplicaciones monoformato y 3 mm en combinaciones de formatos mixtos

ELEMENTAL STONE	scatola - box			pallet		
	pz	mq	kg	box	mq	kg
60x120	2	1,44	28,08	30	43,20	870
60x60	3	1,08	21,49	40	43,20	890
30x60	6	1,08	20,84	40	43,20	860

ELEMENTAL STONE	scatola - box			pallet		
	pz	ml	kg	box	mq	kg
4,6x60 battiscopa	14	8,40	8,40	-	-	-

ELEMENTAL STONE OUTDOOR

Vantaggi tecnici - Technical advantages - Avantages techniques Technische Vorteile - Ventajas técnicas

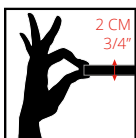

- Lastra monolitica compatta di spessore 2 cm squadrata e rettificata
- Compact monolithic slab 2 cm thick squared and rectified
- Dalle monolithique compacte de 2 cm d'épaisseur, égarriée et rectifiée
- Kompakte monolithische Platte, 2 cm dick, rechteckig und scharfkantig geschliffen
- Losa monolítica compacta de 2 cm de espesor, escuadrada y rectificada.

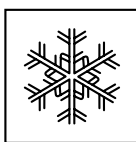

- INGELIVO
- FROST RESISTANT
- INGÉLIF
- FROSTBESTÄNDIG
- RESISTENTE A LA HELADA

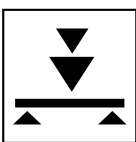

- ELEVATA RESISTENZA AI CARICHI STATICI
- HIGH STATIC LOAD RESISTANCE
- RÉSISTANCE ÉLEVÉE AUX CHARGES STATIQUES
- HOHE STATISCHE BELASTBARKEIT
- ELEVADA RESISTENCIA A LAS CARGAS ESTÁTICAS

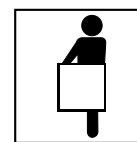

- FACILE DA POSARE
- EASY TO INSTALL
- FACILE À POSER
- VERLEGELEICHT
- FÁCIL DE COLOCAR



- ANTISCIVOLO R11
- ANTI SLIP R11
- ANTIDÉRAPANT R11
- RUTSCHFEST R11
- ANTIDESLIZANTE R11

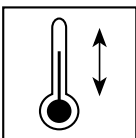

- RESISTENTE AGLI SBALZI TERMICI
- THERMAL SHOCK RESISTANT
- RÉSISTANT AUX ÉCARTS THERMIQUES
- TEMPERATURWECHSELBESTÄNDIG
- RESISTENTE A LAS OSCILACIONES TÉRMICAS



- FACILE DA PULIRE
- EASY TO CLEAN
- FACILE À NETTOYER
- REINIGUNGSLEICHT
- FÁCIL DE LIMPIAR

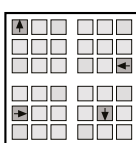

- RIMOVIBILE E RIUTILIZZABILE
- REMOVABLE AND REUSABLE
- DÉMONTABLE ET RÉUTILISABLE
- ENTFERNBAR UND WIEDERVERWENDBAR
- DESMONTABLE Y REUTILIZABLE



- INATTACCABILE DA AGENTI CHIMICI E MUFFE
- IMPERVIOUS TO ATTACK BY CHEMICALS OR MOULD
- RÉSISTANT AUX AGENTS CHIMIQUES ET AUX MOISSISSURES
- UNANGREIFBAR DURCH CHEMISCHE STOFFE UND SCHIMMEL
- RESISTENTE A LOS AGENTES QUÍMICOS Y A LOS MOHOS

Applicazioni - Applications - Applications - Verlegung - Aplicaciones

- Posa diretta su erba
- Direct installation on grass
- Pose direct sur de l'herbe
- Verlegung direkt auf Rasen
- Colocación directa sobre hierba

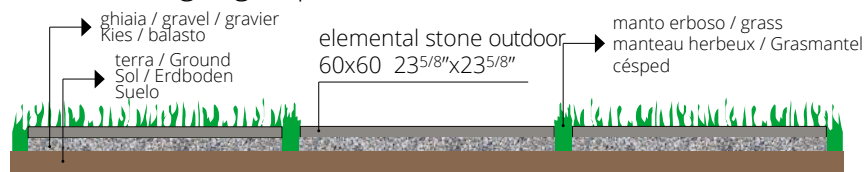

- Posa diretta su ghiaia
- Direct installation over gravel
- Pose direct sur du gravier
- Verlegung direkt auf Kies
- Colocación directa sobre grava



- Posa su massetto cementizio
- Installation on sand-cement screed
- Pose sur chape ciment
- Verlegung auf Zement-Unterbetonblock
- Colocación sobre contrapiso de hormigón

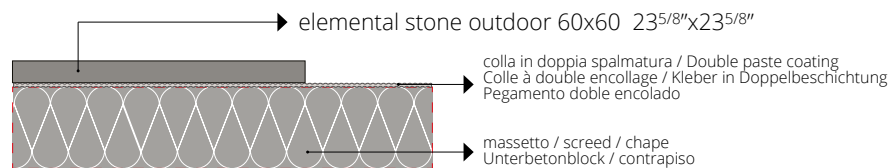

- Posa su piedini fissi o regolabili
- Installation on fixed or adjustable feet
- Pose sur pieds fixes ou réglables
- Verlegung auf feststehende oder regulierbare Füße
- Colocación sobre pies fijos o regulables

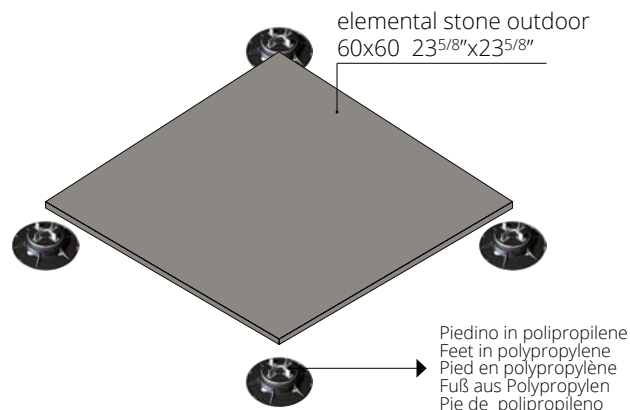

Per le specifiche di utilizzo dei sistemi sopraelevati vedi il sito florim.com
For the specifics on use of raised systems visit the site florim.com
Pour les caractéristiques d'utilisation des systèmes surélevés, voir le site florim.com
Für die Nutzungsbedingungen der Doppelbodensysteme siehe Webseite florim.com
Para las especificaciones de empleo de los sistemas sobreelevados consulte el sitio web florim.com

Le lastre ceramiche sono sottoposte a un trattamento di compattazione termica che assicura resistenza e durata nel tempo. Il bassissimo assorbimento d'acqua rende perciò il materiale ingelivo. Ciò può comportare ristagni d'acqua superficiali anche per materiale installato a regola d'arte. / Ceramic tiles undergo a compacting thermal treatment that ensures resistance and durability. The low level of water absorption makes the slabs frost resistant. This could result in superficial water stagnations even if materials are installed in a workmanlike manner. / Les carreaux de céramique subissent un traitement thermique de compactage qui assure résistance et durabilité. Le bas niveau d'absorption d'eau rend les dalles résistant au gel. Il pourrait en résulter des stagnations d'eau superficielles, même si les dalles ont été installées dans les règles de l'art. / Die Keramikplatten werden einer thermischen Verdichtung unterzogen, welche die Widerstandsfähigkeit und Langlebigkeit sichert. Die extrem niedrige Wasseraufnahme macht das Material frostsicher. Die hohe Materialdichte kann, auch bei einer perfekten Verlegung, eine längere Abtrochnungszeit von angestauntem Wasser zur Folge haben. / Las baldosas cerámicas se someten a un tratamiento de compactación térmica que asegura resistencia y durabilidad. La baja absorción de agua hace que las baldosas resistan al hielo. Esto podría resultar en estancamientos superficiales de agua, incluso si los materiales están instalados según las reglas del arte.

WHITE SANDSTONE



CREAM SANDSTONE

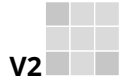

R11
CLASSE B

20 mm 3/4" ↑↓

GREY SANDSTONE



GRES FINE PORCELLANATO

FINE PORCELAIN STONEWARE/GRES CERAME FIN/FEINSTEINZEUG-KOLLEKTIONEN/GRES PORCELANICO FINO
SQUADRATO - SQUARED - EQUARRI - REKTIFIZIERT - ESCUADRADO

20 mm 3/4" ↑↓

	COLOR	SURFACE	60x120	60x60
			23 ⁵ / ₈ "x47 ¹ / ₄ "	23 ⁵ / ₈ "x23 ⁵ / ₈ "
ELEMENTAL STONE	WHITE SANDSTONE	BOCCIARDATO	766427 ■ FL-09100	766432 ■ FL-07300
	CREAM SANDSTONE	BOCCIARDATO	766429 ■ FL-09100	766433 ■ FL-07300
	GREY SANDSTONE	BOCCIARDATO	766430 ■ FL-09100	766434 ■ FL-07300



PEZZI SPECIALI
Special trims/Pièces spèciales/Formstücke
Piezas especiales
pag 150/151

	RESISTENZA ALLA FLESSIONE IN N/mm² <small>N/mm² FLEXURAL STRENGTH TEST / RESISTANCE A LA FLEXION EN N/mm² / BIEGEFESTIGKEIT IN N/mm² / RESISTENCIA A LA FLEXION EN N/mm²</small>	valore medio 52 N/mm²
	Forza di rottura in N (sp. > 7,5 mm) <small>Breaking strength in N (thickness > 7,5 mm) / Force de rupture en N (èp. > 7,5 mm) / Bruchlast in N (Dicke > 7,5 mm) / Fuerza de rotura en N (gr. > 7,5 mm)</small>	valore medio 14000 N

ELEMENTAL STONE	scatola - box			pallet		
	pz	mq	kg	box	mq	kg
60x120 20mm	1	0,72	32,26	30	21,60	1000
60x60 20mm	2	0,72	32,15	30	21,60	990



EXALT

gres porcellanato smaltato
glazed porcelain stoneware
gres cérame émaillé
glasierte Feinsteinzeug
gres Porcelánico esmaltado





EXALT

Exalt è una studiata selezione di marmi che completa il progetto di ricerca intrapreso da Contemporary design; insieme alle serie Antique Marble e Timeless è in grado di fornire una ampia palette cromatica ed estetica capace di soddisfare le differenti esigenze personali e gli stili abitativi in continua evoluzione. Una naturale inclinazione a riconoscere la bellezza autentica permette così di creare un dialogo con il passato mantenendo una moderna freschezza: il design contemporaneo incontra materiali millenari generando nuovi linguaggi estetici.

Exalt is a well-designed selection of marbles that completes the research project undertaken by Contemporary design; along with the Antique Marble and Timeless ranges it can supply a full colour palette and a wide range of aesthetics able to meet different personal needs and constantly-evolving lifestyles. With its natural inclination for authentic beauty it enables a dialogue to be created with the past while maintaining a modern freshness: contemporary design meets thousand-year-old materials, generating new aesthetic languages.

Exalt est une sélection minutieuse de marbres qui complète le projet de recherche entrepris par Contemporary design; avec les séries Antique Marble et Timeless, elle est en mesure de fournir une large palette chromatique et esthétique pour satisfaire les différentes exigences personnelles ainsi que les styles d'habitation en évolution constante. Naturellement portée à reconnaître la beauté authentique, elle permet de créer un dialogue avec le passé tout en conservant une fraîcheur moderne: le design contemporain rencontre des matériaux millénaires en créant de nouveaux langages esthétiques.

Exalt ist eine studierte Auswahl von Marmorsteinen, die das Forschungsprojekt von Contemporary design vervollständigt. Es bietet zusammen mit der Serie Antique Marble und Timeless eine breite farbliche und ästhetische Palette, die den sich konstant ändernden Wohnstilen und verschiedenen persönlichen Anforderungen gerecht wird. Es besitzt die natürliche Neigung, die wahre Schönheit zu erkennen und führt somit einen Dialog mit der Vergangenheit herbei, indem es gleichzeitig dazu eine moderne Frische bewahrt: Zeitgenössisches Design trifft auf jahrtausendalte Materialien und erzeugt neue ästhetische Sprachen.

Exalt se compone de una estudiada selección de mármoles que completa el proyecto de investigación iniciado por Contemporary design; junto a las series Antique Marble y Timeless, Exalt ofrece una amplia paleta cromática y estética que es capaz de satisfacer las distintas necesidades personales y los estilos residenciales en continua evolución. Una inclinación natural a reconocer la belleza auténtica que permite crear un diálogo con el pasado manteniendo un frescor moderno: el diseño contemporáneo se une a materiales milenarios creando nuevos lenguajes estéticos.

EXALT

MAGIC WHITE



FAIRY WHITE

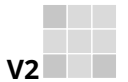



V2

DCOF>
0,42 Wet
(naturale)

9 mm 3/8" ↑↓

GRES PORCELLANATO SMALTATO

GLAZED PORCELAIN STONEWARE / GRES CÉRAMÉ ÉMAILLÉ / GLASIERTE FEINSTEINZEUG / GRES PORCELÁNICO ESMALTADO
SQUADRATO - SQUARED - EQUARRI - REKTIFIZIERT - ESCUADRADO

9 mm 3/8" ↑↓		COLOR	SURFACE	60x120 23 ^{5/8"} x47 ^{1/4"}	60x60 23 ^{5/8"} x23 ^{5/8"}	30x60 11 ^{4/5"} x23 ^{5/8"}
EXALT		MAGIC WHITE	NATURALE	760035 ■ FL-06700	760069 ■ FL-05100	760007 ■ FL-04400
			LUCIDO	760029 ■ FL-08100	760058 ■ FL-06500	760014 ■ FL-05500
		FAIRY WHITE	NATURALE	760039 ■ FL-06700	760075 ■ FL-05100	760012 ■ FL-04400
			LUCIDO	760033 ■ FL-08100	760066 ■ FL-06500	760020 ■ FL-05500

OYSTER SHADE



AMBER SYMPHONY

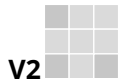



V2
DCOF >
0,42 Wet
(naturale)

9 mm 3/8" ↑↓

GRES PORCELLANATO SMALTATO

GLAZED PORCELAIN STONEWARE / GRES CÉRAME ÉMAILLÉ / GLASIERTE FEINSTEINZEUG / GRES PORCÉLANICO ESMALTADO
SQUADRATO - SQUARED - EQUARRI - REKTIFIZIERT - ESCUADRADO

9 mm 3/8" ↑↓		COLOR	SURFACE	60x120 23 ^{5/8"} x47 ^{1/4"}	60x60 23 ^{5/8"} x23 ^{5/8"}	30x60 11 ^{4/5"} x23 ^{5/8"}
EXALT		OYSTER SHADE	NATURALE	760036 ■ FL-06700	760072 ■ FL-05100	760008 ■ FL-04400
			LUCIDO	760030 ■ FL-08100	760061 ■ FL-06500	760015 ■ FL-05500
		AMBER SYMPHONY	NATURALE	760040 ■ FL-06700	760077 ■ FL-05100	760013 ■ FL-04400
			LUCIDO	760034 ■ FL-08100	760067 ■ FL-06500	760021 ■ FL-05500

SILVER LIGHT



V2









DCOF>
0,42 Wet
(naturele)

9 mm 3/8" ↑↓







GRES PORCELLANATO SMALTATO

GLAZED PORCELAIN STONEWARE / GRES CÉRAMÉ ÉMAILLÉ / GLASIERTE FEINSTEINZEUG / GRES PORCÉLANICO ESMALTADO
SQUADRATO - SQUARED - EQUARRI - REKTIFIZIERT - ESCUADRADO

9 mm 3/8" ↑↓	COLOR	SURFACE	60x120 23 ^{5/8"} x47 ^{1/4"}	60x60 23 ^{5/8"} x23 ^{5/8"}	30x60 11 ^{4/5"} x23 ^{5/8"}
EXALT	SILVER LIGHT	NATURALE	760038 ■ FL-06700	760074 ■ FL-05100	760011 ■ FL-04400
		LUCIDO	760032 ■ FL-08100	760064 ■ FL-06500	760017 ■ FL-05500

9 mm 3/8" ↑↓		COLOR	SURFACE	30x30 11 4/5" x 11 4/5"  mosaico tessere 3x3 pz/box 11	30x30 11 4/5" x 11 4/5"  mosaico 3D tessere 5x30 pz/box 8	15x60 6" x 23 5/8"  modulo listello sfalsato mix naturale/lucido pz/box 6	0,5x60 1/4" x 23 5/8" matita inox pz/box 4
EXALT		MAGIC WHITE	NATURALE	760950 ▲ FL-01600	760962 ▲ FL-01900	760944 ▲ FL-03100	719674 ▲ FL-03100
		LUCIDO	760956 ▲ FL-01800	760971 ▲ FL-02100			
		FAIRY WHITE	NATURALE	760951 ▲ FL-01600	760963 ▲ FL-01900	760945 ▲ FL-03100	
		LUCIDO	760957 ▲ FL-01800	760972 ▲ FL-02100			
		OYSTER SHADE	NATURALE	760952 ▲ FL-01600	760964 ▲ FL-01900	760946 ▲ FL-03100	
		LUCIDO	760958 ▲ FL-01800	760973 ▲ FL-02100			
		AMBER SYMPHONY	NATURALE	760953 ▲ FL-01600	760965 ▲ FL-01900	760947 ▲ FL-03100	
		LUCIDO	760959 ▲ FL-01800	760974 ▲ FL-02100			
		SILVER LIGHT	NATURALE	760955 ▲ FL-01600	760967 ▲ FL-01900	760949 ▲ FL-03100	
		LUCIDO	760961 ▲ FL-01800	760976 ▲ FL-02100			

PEZZI SPECIALI/SPECIAL TRIMS/PIÈCES SPÉCIALES/FORMSTÜCKE/PIEZAS ESPECIALES

9 mm 3/8" ↑↓		COLOR	SURFACE	4,6x60 1 4/5" x 23 5/8"  battiscopa
EXALT		MAGIC WHITE	NATURALE	760977 ◆ FL-01600
		LUCIDO	760983 ◆ FL-01600	
		FAIRY WHITE	NATURALE	760978 ◆ FL-01600
		LUCIDO	760984 ◆ FL-01600	
		OYSTER SHADE	NATURALE	760979 ◆ FL-01600
		LUCIDO	760985 ◆ FL-01600	
		AMBER SYMPHONY	NATURALE	760980 ◆ FL-01600
		LUCIDO	760986 ◆ FL-01600	
	SILVER LIGHT	NATURALE	760982 ◆ FL-01600	
	LUCIDO	761027 ◆ FL-01600		



3D: Si consiglia la posa con stucco epossidico per ambienti bagnati o sottoposti a forte umidità. / 3D: We recommend laying with epoxy putty for wet environments or those subject to strong humidity. / 3D: pose conseillée avec mortier époxy pour environnements très humides ou mouillés. / 3D: In nassen oder starker Feuchtigkeit ausgesetzten Bereichen empfiehlt sich die Verlegung mit Epoxidstuck. / 3D: En ambientes mojados o muy húmedos, se recomienda realizar la colocación con estuco epoxidico.

Per un effetto ottimale della posa, florim suggerisce di mantenere 2 mm di fuga per pose monoformato e 3 mm per combinare formati misti. - For optimal installation results, florim recommends maintaining a joint of 2 mm 1/12" for single format installations and 3 mm 1/8" to combine mixed formats. - Pour réaliser une pose parfaite, florim suggère de maintenir 2 mm de joint pour la pose des monoformats, et 3 mm pour les combinaisons de formats mixtes. - Um einen optimalen effekt beim verlegen zu erzielen empfiehlt florim eine 2 mm fugе bei einformatigen verlegungen und 3 mm fugе bei formatkombinationen Para lograr los máximos resultados en la posa del producto, florim aconseja 2 mm de junta en aplicaciones monoformato y 3 mm en combinaciones de formatos mixtos

EXALT	scatola - box			pallet		
	pz	mq	kg	box	mq	kg
60x120	2	1,44	28,08	30	43,20	870
60x60	3	1,08	21,49	40	43,20	890
30x60	6	1,08	21,49	40	43,20	890

EXALT	scatola - box			pallet		
	pz	ml	kg	box	mq	kg
4,6x60 battiscopa	14	8,40	8,40	-	-	-



HI-WOOD

gres porcellanato smaltato
glazed porcelain stoneware
gres cérame émaillé
glasierte Feinsteinzeug
gres Porcelánico esmaltado





HI-WOOD

Una lucentezza nuova riempie la casa con la naturale eleganza di una materia senza tempo: il legno che **Hi-Wood** ridefinisce mantenendone la sua essenziale semplicità originaria. I riflessi brillanti della finitura lucida mettono in evidenza dettagli essenziali che rendono ricercata ogni atmosfera. La superficie naturale evoca un gusto dall'estetica lineare con una visione delicata dell'abitare. Due anime differenti ma in stretta connessione, capaci di una vitalità forte in grado di portare in casa la bellezza vibrante della natura.

A new sparkle fills the home with the natural elegance of a timeless material – wood, which **Hi-Wood** redefines whilst maintaining its original essential simplicity. The brilliant reflections of the gloss finish highlight essential details, giving a refined quality to any surroundings. The matt surface evokes a taste with linear aesthetics and a gentle vision of the living environment. These are two different but closely connected materials, with a strong vitality that brings the vibrant beauty of nature into the home.

La maison se remplit d'une nouvelle brillance avec l'élégance naturelle d'une matière intemporelle: le bois que **Hi-Wood** redéfinit tout en conservant sa simplicité essentielle et naturelle. Les reflets de la finition brillante soulignent les détails essentiels qui apportent du raffinement à chaque atmosphère. La surface naturelle évoque un style à l'esthétique linéaire avec une vision délicate de l'habiter. Deux âmes à la fois différentes et étroitement liées, dont la forte vitalité fait entrer dans la maison la beauté vibrante de la nature.

Ein neuer Glanz erfüllt das Haus mit der natürlichen Eleganz eines zeitlosen Materials: Holz, das **Hi-Wood** neu definiert und dabei seine ursprüngliche essentielle Schlichtheit bewahrt. Die funkelnden Reflexe der glänzenden Ausführung heben wesentliche Details hervor, die jede Atmosphäre in ein edles Licht tauchen. Die matte Oberfläche erinnert an eine lineare Ästhetik mit einer zarten Vision des Wohnstils. Zwei verschiedene, aber in enger Verbindung stehende Seelen von derart starker Lebendigkeit, dass sie die pulsierende Schönheit der Natur auch zwischen den eigenen vier Wänden herbeizaubern.

Un brillo nuevo llena la casa con la elegancia natural de una materia atemporal: la madera que **Hi-Wood** redefine manteniendo su simplicidad original y esencial. Los reflejos radiantes del acabado brillante destacan detalles esenciales que convierten los ambientes en lugares sofisticados. La superficie natural evoca un gusto con una estética lineal y una visión delicada de la vivienda. Dos almas distintas pero íntimamente vinculadas, con una vitalidad fuerte capaz de llevar a casa la belleza vibrante de la naturaleza.

HI-WOOD

ALMOND



WALNUT

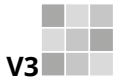

V3



R10
Classe A
(naturale)

DCOF >
0,42 Wet
(naturale)

9 mm 3/8" ↑↓

GRES PORCELLANATO SMALTATO

GLAZED PORCELAIN STONEWARE / GRES CÉRAMÉ ÉMAILLÉ / GLASIERTE FEINSTEINZEUG / GRES PORCELÁNICO ESMALTADO
SQUADRATO - SQUARED - EQUARRI - REKTIFIZIERT - ESCUADRADO

9 mm 3/8" ↑↓		COLOR	SURFACE	20x120 7 ^{7/8"} x47 ^{1/4"}
HI-WOOD		ALMOND	NATURALE	759961 ■ FL-05800
			LUCIDO	759956 ■ FL-07000
		WALNUT	NATURALE	759962 ■ FL-05800
			LUCIDO	759957 ■ FL-07000

GREY OAK



SMOKE GREY

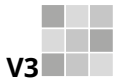

V3

R10
Classe A
(naturale)

DCOF >
0,42 Wet
(naturale)

9 mm 3/8" ↑↓

GRES PORCELLANATO SMALTATO

GLAZED PORCELAIN STONWARE / GRES CÉRAME ÉMAILLÉ / GLASIERTE FEINSTEINZEUG / GRES PORCELÁNICO ESMALTADO
SQUADRATO - SQUARED - EQUARRI - REKTIFIZIERT - ESCUADRADO

9 mm 3/8" ↑↓		COLOR	SURFACE	20x120 7 ^{11/16"} x47 ^{1/4"}
HI-WOOD		GREY OAK	NATURALE	759960 ■ FL-05800
			LUCIDO	759955 ■ FL-07000
		SMOKE GREY	NATURALE	759963 ■ FL-05800
			LUCIDO	759958 ■ FL-07000

HI-WOOD

DARK OAK

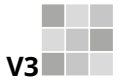

V3

R10
Classe A
(naturale)







DCOF >
0,42 Wet
(naturale)

9 mm 3/8" ↑







GRES PORCELLANATO SMALTATO

GLAZED PORCELAIN STONEWARE / GRES CÉRAMÉ ÉMAILLÉ / GLASIERTE FEINSTEINZEUG / GRES PORCÉLANICO ESMALTADO
SQUADRATO - SQUARED - EQUARRI - REKTIFIZIERT - ESCUADRADO

9 mm 3/8" ↑	COLOR	SURFACE	20x120 7 ^{7/8"} x47 ^{1/4"}
HI-WOOD	DARK OAK	NATURALE	759964 ■ FL-05800
		LUCIDO	759959 ■ FL-07000

9 mm 3/8" ↑↓		COLOR	SURFACE	15x40 6"x15 3/4"  modulo listello sfalsato pz/box 4	0,5x60 1/4"x23 5/8"  matita inox pz/box 4
HI-WOOD		ALMOND	NATURALE	761779 ▲ FL-02000	719674 ▲ FL-03100
			LUCIDO	761784 ▲ FL-02400	
		WALNUT	NATURALE	761780 ▲ FL-02000	
			LUCIDO	761788 ▲ FL-02400	
		GREY OAK	NATURALE	761783 ▲ FL-02000	
			LUCIDO	761785 ▲ FL-02400	
		SMOKE GREY	NATURALE	761782 ▲ FL-02000	
			LUCIDO	761786 ▲ FL-02400	
		DARK OAK	NATURALE	761781 ▲ FL-02000	
			LUCIDO	761787 ▲ FL-02400	

PEZZI SPECIALI
SPECIAL TRIMS/PIÈCES SPÉCIALES/FORMSTÜCKE/PIEZAS ESPECIALES

9 mm 3/8" ↑↓		COLOR	SURFACE	4,6x60 1 4/5"x23 5/8"  battiscopa
HI-WOOD		ALMOND	NATURALE	761790 ◆ FL-01600
			LUCIDO	761794 ◆ FL-01600
		WALNUT	NATURALE	761789 ◆ FL-01600
			LUCIDO	761795 ◆ FL-01600
		GREY OAK	NATURALE	761793 ◆ FL-01600
			LUCIDO	761798 ◆ FL-01600
		SMOKE GREY	NATURALE	761792 ◆ FL-01600
			LUCIDO	761797 ◆ FL-01600
		DARK OAK	NATURALE	761791 ◆ FL-01600
			LUCIDO	761796 ◆ FL-01600



Nelle operazioni di posa a listoni sfalsati, si raccomanda sempre di fare in modo che il lato maggiore della piastrella termini a circa un terzo della lunghezza di quelle accanto (posa sfalsata "a 1/3"). - When installing staggered strips, we recommend that the tile's longer side should always end at about one-third of the length of the tiles next to it ("1/3" staggered installation) - Lors de la pose des listels décalés, il faut toujours faire en sorte que le côté le plus grand du carreau se trouve à environ 1/3 de la longueur des carreaux d'à côté (pose décalée "à 1/3"). - Beim Verlegen der Leisten in versetzter Form ist zu beachten, dass die höhere Seite der Fliese immer circa bei einem Drittel der Länge der sich daneben befindlichen Fliesen abschließt ("Um 1/3" versetzte Verlegung). - En las operaciones de colocación de listones escalonados, se recomienda hacerlo siempre de forma tal que el lado mayor del azulejo termine teniendo alrededor de un tercio de la longitud de los contiguos (colocación escalonada "a 1/3").

Per un effetto ottimale della posa, florim suggerisce di mantenere 2 mm di fuga per pose monoformato e 3 mm per combinare formati misti. - For optimal installation results, florim recommends maintaining a joint of 2 mm 1/16" for single format installations and 3 mm 1/8" to combine mixed formats. - Pour réaliser une pose parfaite, florim suggère de maintenir 2 mm de joint pour la pose des monoformats, et 3 mm pour les combinaisons de formats mixtes. - Um einen optimalen effekt beim verlegen zu erzielen empfiehlt florim eine 2 mm fugе bei einformatigen verlegungen und 3 mm fugе bei formatkombinationen. Para lograr los máximos resultados en la posa del producto, florim aconseja 2 mm de junta en aplicaciones monoformato y 3 mm en combinaciones de formatos mixtos.

HI-WOOD	scatola - box			pallet		
	pz	mq	kg	box	mq	kg
20x120	6	1,44	28,08	24	34,56	700

HI-WOOD	scatola - box			pallet		
	pz	ml	kg	box	mq	kg
4,6x60 battiscopa	14	8,40	8,40	-	-	-



MAPS

gres porcellanato smaltato
glazed porcelain stoneware
gres cérame émaillé
glasierte Feinsteinzeug
gres Porcelánico esmaltado





MAPS

Maps rappresenta la fusione perfetta tra estetica e funzionalità, ragione e sentimento. La sua raffinata informalità gli permette di interpretare uno stile dallo spirito contemporaneo, sempre attuale, in continuo divenire con il design dell'abitare. La trama del vissuto si confonde con le linee leggere e pulite di una serie che si ispira alla semplicità industriale del cemento da cui trae l'aspetto forte e inalterabile nel tempo.

Maps represents the perfect blend of aesthetics and functionality, sense and sensibility. Its informal elegance enables it to interpret the spirit of the modern age, in a style that is always contemporary and continually evolving with the design of living spaces. The texture of past experience merges with the light, clean lines of a range inspired by the industrial simplicity of concrete, which gives it the appearance of strength and permanence.

Maps conjugue à merveille esthétique et fonctionnalité, raison et sentiments. Son élégance décontractée lui permet d'interpréter un style à l'esprit contemporain et toujours tendance, en évolution continue avec le design de l'habiter. L'effet de vécu se mêle aux lignes légères et épurées d'une série qui s'inspire à la simplicité industrielle du ciment, lui conférant son aspect solide et inaltérable dans le temps.

Maps stellt die perfekte Verbindung von Ästhetik und Funktionalität, von Rationalität und Gefühl dar. Die elegante Informalität ermöglicht die Darstellung eines modernen, stets aktuellen Stils, in kontinuierlicher Evolution mit dem Design des Wohnens. Das Muster des Gelebten vermischt sich mit den fließenden und reinen Linien einer Serie, die sich an der industriellen Schlichtheit des Zements inspiriert, dem sie das dauerhaft starke und unveränderliche Aussehen verdankt.

Maps representa una perfecta fusión entre estética y funcionalidad, razón y sentimiento. Su refinada informalidad le permite interpretar un estilo con espíritu contemporáneo, siempre actual, en continua evolución con el diseño del ambiente. La trama del material "vívido" se combina con las líneas ligeras y sobrias de una serie inspirada en la simplicidad industrial del cemento, que le da su aspecto fuerte e inalterable en el tiempo.

MAPS

MAPS WHITE



MAPS BEIGE



V2
MAPS WHITE

V3
MAPS BEIGE

R10
CLASSE A
(naturale)

R11
CLASSE C
(bocciardato)

DCOF>
0,42 Wet

9 mm 3/8" ↑↓

GRES PORCELLANATO SMALTATO

GLAZED PORCELAIN STONEWARE / GRES CÉRAMÉ ÉMAILLÉ / GLASIERTE FEINSTEINZEUG / GRES PORCELÁNICO ESMALTADO
SQUADRATO - SQUARED - EQUARRI - REKTIFIZIERT - ESCUADRADO

9 mm 3/8" ↑↓		COLOR	SURFACE	60x120 23 ^{5/8"} x47 ^{1/4"}	80x80 31 ^{1/2"} x31 ^{1/2"}	60x60 23 ^{5/8"} x23 ^{5/8"}	30x60 11 ^{4/5"} x23 ^{5/8"}
MAPS	MAPS WHITE	NATURALE		747140 ■ FL-06700	754072 ■ FL-06400	747134 ■ FL-04600	747129 ■ FL-03800
		BOCCIARDATO		-	-	-	747123 ■ FL-03800
	MAPS BEIGE	NATURALE		747141 ■ FL-06700	754073 ■ FL-06400	747136 ■ FL-04600	747130 ■ FL-03800
		BOCCIARDATO		-	-	-	747124 ■ FL-03800

MAPS LIGHT GREY



MAPS DARK GREY

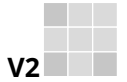

V2
R10
CLASSE A
 (naturale)



R11
CLASSE C
 (bocciardato)

DCOF>
 0,42 Wet

9 mm 3/8" ↑↓

GRES PORCELLANATO SMALTATO

GLAZED PORCELAIN STONEWARE / GRES CÉRAME ÉMAILLÉ / GLASIERTE FEINSTEINZEUG / GRES PORCELÁNICO ESMALTADO
 SQUADRATO - SQUARED - EQUARRI - REKTIFIZIERT - ESCUADRADO

9 mm 3/8" ↑↓		COLOR	SURFACE	60x120 23 ^{5/8"} x47 ^{1/4"}	80x80 31 ^{1/2"} x31 ^{1/2"}	60x60 23 ^{5/8"} x23 ^{5/8"}	30x60 11 ^{4/5"} x23 ^{5/8"}
MAPS		MAPS LIGHT GREY	NATURALE	747142 ■ FL-06700	753938 ■ FL-06400	747137 ■ FL-04600	747131 ■ FL-03800
			BOCCIARDATO	-	-	-	747125 ■ FL-03800
		MAPS DARK GREY	NATURALE	747143 ■ FL-06700	754074 ■ FL-06400	747138 ■ FL-04600	747132 ■ FL-03800
			BOCCIARDATO	-	-	-	747126 ■ FL-03800

MAPS

MAPS GRAPHITE

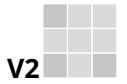

V2
R10
CLASSE A
 (naturale)

R11
CLASSE C
 (bocciardato)

DCOF>
 0,42 Wet









9 mm 3/8" ↑↓

GRES PORCELLANATO SMALTATO

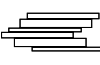





GLAZED PORCELAIN STONEWARE / GRES CÉRAMÉ ÉMAILLÉ / GLASIERTE FEINSTEINZEUG / GRES PORCÉLANICO ESMALTADO
 SQUADRATO - SQUARED - EQUARRI - REKTIFIZIERT - ESCUADRADO

9 mm 3/8" ↑↓	COLOR	SURFACE	60x120	80x80	60x60	30x60
			23 ^{5/8"} x47 ^{1/4"}	31 ^{1/2"} x31 ^{1/2"}	23 ^{5/8"} x23 ^{5/8"}	11 ^{4/5"} x23 ^{5/8"}
MAPS	MAPS GRAPHITE	NATURALE	747145 ■ FL-06700	753939 ■ FL-06400	747139 ■ FL-04600	747133 ■ FL-03800
		BOCCIARDATO	-	-	-	747127 ■ FL-03800

Contemporary design

9 mm 3/8" ↑↓		COLOR	SURFACE	30x30 11 4/5" x 11 4/5"  mosaico tessere 3x3 pz/box 11	30x30 11 4/5" x 11 4/5"  mosaico 3D tessere 5x5 pz/box 8	21x40 8 1/4" x 15 3/4"  modulo listello sfalsato pz/box 5	0,5x60 1/4" x 23 5/8" matita inox pz/box 4
MAPS		MAPS WHITE	NATURALE	747464 ▲ FL-01600	747470 ▲ FL-01900	747475 ▲ FL-01600	719674 ▲ FL-03100
		MAPS BEIGE	NATURALE	747465 ▲ FL-01600	747471 ▲ FL-01900	747476 ▲ FL-01600	
		MAPS LIGHT GREY	NATURALE	747466 ▲ FL-01600	747452 ▲ FL-01900	747477 ▲ FL-01600	
		MAPS DARK GREY	NATURALE	747467 ▲ FL-01600	747472 ▲ FL-01900	747478 ▲ FL-01600	
		MAPS GRAPHITE	NATURALE	747469 ▲ FL-01600	747473 ▲ FL-01900	747479 ▲ FL-01600	

PEZZI SPECIALI/SPECIAL TRIMS/PIÈCES SPÉCIALES/FORMSTÜCKE/PIEZAS ESPECIALES

9 mm 3/8" ↑↓		COLOR	SURFACE	4,6x60 1 4/5" x 23 5/8"  battiscopa
MAPS		MAPS WHITE	NATURALE	747480 ◆ FL-01600
		MAPS BEIGE	NATURALE	747481 ◆ FL-01600
		MAPS LIGHT GREY	NATURALE	747482 ◆ FL-01600
		MAPS DARK GREY	NATURALE	747483 ◆ FL-01600
		MAPS GRAPHITE	NATURALE	747484 ◆ FL-01600



3D: Si consiglia la posa con stucco epossidico per ambienti bagnati o sottoposti a forte umidità. / 3D: We recommend laying with epoxy putty for wet environments or those subject to strong humidity. / 3D: pose conseillée avec mortier époxy pour environnements très humides ou mouillés. / 3D: In nassen oder starker Feuchtigkeit ausgesetzten Bereichen empfiehlt sich die Verlegung mit Epoxidstuck. / 3D: En ambientes mojados o muy húmedos, se recomienda realizar la colocación con estuco epoxidico.

Per un effetto ottimale della posa, florim suggerisce di mantenere 2 mm di fuga per pose monoformato e 3 mm per combinare formati misti. - For optimal installation results, florim recommends maintaining a joint of 2 mm 1/12" for single format installations and 3 mm 1/8" to combine mixed formats. - Pour réaliser une pose parfaite, florim suggère de maintenir 2 mm de joint pour la pose des monoformats, et 3 mm pour les combinaisons de formats mixtes. - Um einen optimalen effekt beim verlegen zu erzielen empfiehlt florim eine 2 mm fuge bei einformatigen verlegungen und 3 mm fuge bei formatkombinationen Para lograr los máximos resultados en la posá del producto, florim aconseja 2 mm de junta en aplicaciones monoformato y 3 mm en combinaciones de formatos mixtos.

MAPS	scatola - box			pallet		
	pz	mq	kg	box	mq	kg
60x120	2	1,44	28,08	30	43,20	870
80x80	2	1,28	24,96	40	51,20	1030
60x60	3	1,08	21,06	40	43,20	870
30x60	6	1,08	21,49	40	43,20	890

MAPS	scatola - box			pallet		
	pz	ml	kg	box	mq	kg
4,6x60 battiscopa	14	8,40	8,40	-	-	-

MAPS OUTDOOR

Vantaggi tecnici - Technical advantages - Avantages techniques Technische Vorteile - Ventajas técnicas

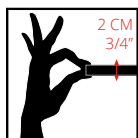

- Lastra monolitica compatta di spessore 2 cm squadrata e rettificata
- Compact monolithic slab 2 cm thick squared and rectified
- Dalle monolithique compacte de 2 cm d'épaisseur, égarriée et rectifiée
- Kompakte monolithische Platte, 2 cm dick, rechteckig und scharfkantig geschliffen
- Losa monolítica compacta de 2 cm de espesor, esquadrada y rectificada.

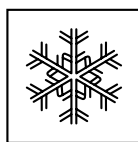

- INGELIVO
- FROST RESISTANT
- INGÉLIF
- FROSTBESTÄNDIG
- RESISTENTE A LA HELADA

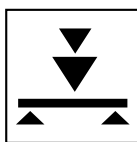

- ELEVATA RESISTENZA AI CARICHI STATICI
- HIGH STATIC LOAD RESISTANCE
- RÉISTANT AUX ÉLEVÉES AUX CHARGES STATIQUES
- HOHE STATISCHE BELASTBARKEIT
- ELEVADA RESISTENCIA A LAS CARGAS ESTÁTICAS

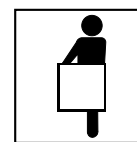

- FACILE DA POSARE
- EASY TO INSTALL
- FACILE À POSER
- VERLEGELEICHT
- FÁCIL DE COLOCAR



- ANTISCIVOLO R11
- ANTI SLIP R11
- ANTIDÉRAPANT R11
- RUTSCHFEST R11
- ANTIDESLIZANTE R11

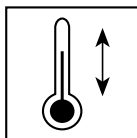

- RESISTENTE AGLI SBALZI TERMICI
- THERMAL SHOCK RESISTANT
- RÉISTANT AUX ÉCARTS THERMIQUES
- TEMPERATURWECHSELBESTÄNDIG
- RESISTENTE A LAS OSCILACIONES TÉRMICAS



- FACILE DA PULIRE
- EASY TO CLEAN
- FACILE À NETTOYER
- REINIGUNGSLEICHT
- FÁCIL DE LIMPIAR

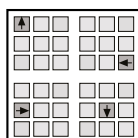

- RIMOVIBILE E RIUTILIZZABILE
- REMOVABLE AND REUSABLE
- DÉMONTABLE ET RÉUTILISABLE
- ENTFERNBAR UND WIEDERVERWENDBAR
- DESMONTABLE Y REUTILIZABLE



- INATTACCABILE DA AGENTI CHIMICI E MUFFE
- IMPERVIOUS TO ATTACK BY CHEMICALS OR MOULD
- RÉISTANT AUX AGENTS CHIMIQUES ET AUX MOISSISSURES
- UNANGREIFBAR DURCH CHEMISCHE STOFFE UND SCHIMMEL
- RESISTENTE A LOS AGENTES QUÍMICOS Y A LOS MOHOS

Applicazioni - Applications - Applications - Verlegung - Aplicaciones

- Posa diretta su erba
- Direct installation on grass
- Pose direct sur de l'herbe
- Verlegung direkt auf Rasen
- Colocación directa sobre hierba



- Posa diretta su ghiaia
- Direct installation over gravel
- Pose direct sur du gravier
- Verlegung direkt auf Kies
- Colocación directa sobre grava



- Posa su massetto cementizio
- Installation on sand-cement screed
- Pose sur chape ciment
- Verlegung auf Zement-Unterbetonblock
- Colocación sobre contrapiso de hormigón

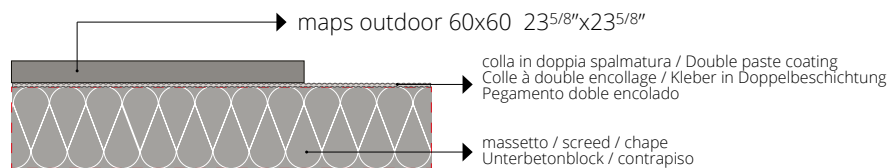

- Posa su piedini fissi o regolabili
- Installation on fixed or adjustable feet
- Pose sur pieds fixes ou réglables
- Verlegung auf feststehende oder regulierbare Füße
- Colocación sobre pies fijos o regulables

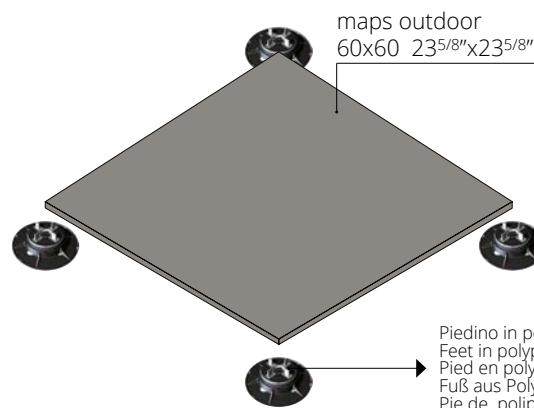

Per le specifiche di utilizzo dei sistemi sopraelevati vedi il sito florim.com
For the specifics on use of raised systems visit the site florim.com
Pour les caractéristiques d'utilisation des systèmes surélevés, voir le site florim.com
Für die Nutzungsbedingungen der Doppelbodensysteme siehe Webseite florim.com
Para las especificaciones de empleo de los sistemas sobreelevados consulte el sitio web florim.com

Le lastre ceramiche sono sottoposte a un trattamento di compattazione termica che assicura resistenza e durata nel tempo. Il bassissimo assorbimento d'acqua rende perciò il materiale ingelivo. Ciò può comportare ristagni d'acqua superficiali anche per materiale installato a regola d'arte. / Ceramic tiles undergo a compacting thermal treatment that ensures resistance and durability. The low level of water absorption makes the slabs frost resistant. This could result in superficial water stagnations even if materials are installed in a workmanlike manner. / Les carreaux de céramique subissent un traitement thermique de compactage qui assure résistance et durabilité. Le bas niveau d'absorption d'eau rend les dalles résistant au gel. Il pourrait en résulter des stagnations d'eau superficielles, même si les dalles ont été installées dans les règles de l'art. / Die Keramikplatten werden einer thermischen Verdichtung unterzogen, welche die Widerstandsfähigkeit und Langlebigkeit sichert. Die extrem niedrige Wasseraufnahme macht das Material frostsicher. Die hohe Materialdichte kann, auch bei einer perfekten Verlegung, eine längere Abtrochnungszeit von angestaumtem Wasser zur Folge haben. / Las baldosas cerámicas se someten a un tratamiento de compactación térmica que asegura resistencia y durabilidad. La baja absorción de agua hace que las baldosas resistan al hielo. Esto podría resultar en estancamientos superficiales de agua, incluso si los materiales están instalados según las reglas del arte.

MAPS BEIGE



MAPS LIGHT GREY

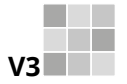

V3

R11
CLASSE B

20 mm 3/4" ↑↓

GRES FINE PORCELLANATO

FINE PORCELAIN STONEWARE/GRES CERAME FIN/FEINSTEINZEUG-KOLLEKTIONEN/GRES PORCELANICO FINO
SQUADRATO - SQUARED - EQUARRI - REKTIFIZIERT - ESCUADRADO

20 mm 3/4" ↑↓	COLOR	SURFACE	60x60 23 ^{5/8} "x23 ^{5/8} "
	MAPS BEIGE	BOCCIARDATO	747135 ■ FL-07300
	MAPS LIGHT GREY	BOCCIARDATO	747714 ■ FL-07300

MAPS

	RESISTENZA ALLA FLESSIONE IN N/mm² N/mm ² FLEXURAL STRENGTH TEST / RESISTANCE A LA FLEXION EN N/mm ² / BIEGEFESTIGKEIT IN N/mm ² / RESISTENCIA A LA FLEXION EN N/mm ²	valore medio 52 N/mm²
	Forza di rottura in N (sp. > 7,5 mm) Breaking strength in N (thickness > 7,5 mm) / Force de rupture en N (ép. > 7,5 mm) / Bruchlast in N (Dicke > 7,5 mm) / Fuerza de rotura en N (gr. > 7,5 mm)	valore medio 14000 N



PEZZI SPECIALI

Special trims/Pièces spéciales/Formstücke
Piezas especiales
pag 150/151

MAPS	scatola - box			pallet		
	pz	mq	kg	box	mq	kg
60x60 20mm	2	0,72	32,15	30	21,60	990



MATCH-UP

gres fine porcellanato
fine porcelain stoneware
grès cérame fin
feinsteinzeug-kollektionen
gres porcelánico fino





Museo sperimentale d'arte
contemporanea
april
Tor
Ga

MATCH-UP

Dall'incontro tra due materie diverse nasce un progetto contemporaneo e di tendenza che mescola insieme superfici, colori e linguaggi per proporre accostamenti originali. **Match-Up** è un gioco di contrasti che attraverso un patchwork materico si presta ad un equilibrato mix and match di stili e colorazioni. Sono due le superfici di partenza con cui creare molteplici accostamenti: un effetto cemento, dall'estetica urbana e industriale, e un originale effetto graniglia che amalgama insieme elementi materici tono su tono di forme irregolari e dimensioni variabili.

The union of two different materials has resulted in a contemporary, trendy project that mixes surfaces, colours and languages to offer original combinations. **Match-Up** features an interplay of different contrasts through tactile patchwork suited to a balanced mix and match of styles and colours. There are two basic surfaces that can be used to create multiple combinations: a concrete effect with an urban and industrial aesthetic and an original marble agglomerate effect that blends tone-on-tone tactile elements with irregular shapes and varying sizes.

Contemporain et tendance, mélangeant surfaces, couleurs et langages pour donner lieu à des associations originales: tel est le projet né de la rencontre entre deux matières différentes. **Match-Up** est un jeu de contrastes qui à travers un patchwork de matières se prêtant à un mix and match équilibré de styles et de couleurs. Deux surfaces de base permettent de créer une multitude d'associations: un effet béton à l'esthétique urbaine et industrielle et un effet grenaille original qui amalgame des éléments de matière ton sur ton, de forme irrégulière et de taille variable.

Aus dem Spannungsfeld von zwei unterschiedlichen Materialien geht ein zeitgemäßes, trendiges Konzept hervor, das durch einen Mix aus Oberflächen, Farben und Ausdrucksformen originelle Kombinationen bietet. **Match-Up** ist ein Spiel der Kontraste. Es lockert die Schlichtheit minimalistischer Interieurs durch ein Patchwork aus Materialoptiken in einem ausgewogenen Mix and Match aus Stilthemen und Farben auf. Aus zwei Ausgangsoberflächen lassen sich vielfältige Kombinationen, die Mode- und Lifestyle-Trends aufgreifen, realisieren: eine Betonoptik für einen urbanen Industrie-Look und eine originelle Ceppo di Grè-Optik, bei der Ton in Ton Materialfragmente mit unregelmäßiger Form und unterschiedlicher Größe harmonisch zusammengefügt sind.

A partir de la suma de dos materias distintas nace un proyecto contemporáneo y de moda que mezcla superficies, colores y lenguajes para proponer combinaciones originales. **Match-Up** brinda un juego de contrastes por medio de un patchwork matérico que se presta a un equilibrado mix and match de estilos y coloraciones. Dos son las superficies de partida con las que crear múltiples combinaciones: un efecto cemento, de estética urbana e industrial, y un original efecto arenilla que amalgama conjuntamente elementos matéricos tono sobre tono de formas irregulares y medidas variables.

MATCH-UP

SUGAR



SUGAR MIX



R10
CLASSE B
(comfort)

R11
CLASSE B
(grip)

DCOF>
0,42 Wet

BS EN 16165
ANNEX C
>36 Wet
slider 4S

9 mm 3/8" ↑↓



R10
CLASSE B
(comfort)

DCOF>
0,42 Wet
(comfort)

BS EN 16165
ANNEX C
>36 Wet
slider 4S
(comfort)

6 mm 1/4" ↑↓

FLORM OVERSIZE
magnUm

GRES FINE PORCELLANATO
FINE PORCELAIN STONEWARE/GRES CERAME FIN/FEINSTEINZEUG-KOLLEKTIONEN/GRES PORCELANICO FINO
SQUADRATO - SQUARED - EQUARRI - REKTIFIZIERT - ESCUADRADO

9 mm 3/8" ↑↓		COLOR	SURFACE	60x120 23 ^{5/8"} x47 ^{1/4"}	60x60 23 ^{5/8"} x23 ^{5/8"}	30x60 11 ^{4/5"} x23 ^{5/8"}
MATCH-UP		SUGAR	COMFORT	772185 ■ FL-06700	772235 ■ FL-04600	772223 ■ FL-03800
			GRIP	772186 ■ FL-06700	-	-
		SUGAR MIX	COMFORT	772199 ■ FL-06700	772242 ■ FL-04600	772230 ■ FL-03800
			GRIP	772200 ■ FL-06700	-	-

6 mm 1/4" ↑↓		COLOR	SURFACE	120x280 47 ^{1/4"} x110 ^{1/4"}	120x240 47 ^{1/4"} x94 ^{1/2"}	120x120 47 ^{1/4"} x47 ^{1/4"}	60x120 23 ^{5/8"} x47 ^{1/4"}
MATCH-UP		SUGAR	COMFORT	772304 ■ FL-09100	772301 ■ FL-08400	772302 ■ FL-07000	772303 ■ FL-06700
			COMFORT	772311 ■ FL-09100	772318 ■ FL-08400	772325 ■ FL-07000	772332 ■ FL-06700
		SUGAR MIX	GLOSSY	772305 ■ FL-11900	772306 ■ FL-11300	772307 ■ FL-09300	772308 ■ FL-08600

COOKIE



COOKIE MIX



R10
CLASSE B
(comfort)

R11
CLASSE B
(grip)

DCOF>
0,42 Wet

BS EN 16165
ANNEX C
>36 Wet
slider 4S

9 mm 3/8" ↓↑



R10
CLASSE B
(comfort)

DCOF>
0,42 Wet
(comfort)

BS EN 16165
ANNEX C
>36 Wet
slider 4S
(comfort)

6 mm 1/4" ↓↑

FLORM OVERSIZE
magnUm

GRES FINE PORCELLANATO
FINE PORCELAIN STONEWARE/GRES CERAME FIN/FEINSTEINZEUG-KOLLEKTIONEN/GRES PORCELANICO FINO
SQUADRATO - SQUARED - EQUARRI - REKTIFIZIERT - ESCUADRADO

		COLOR	SURFACE	60x120 23 ^{5/8"} x47 ^{1/4"}	60x60 23 ^{5/8"} x23 ^{5/8"}	30x60 11 ^{4/5"} x23 ^{5/8"}
MATCH-UP		COOKIE	COMFORT	772187 ■ FL-06700	772236 ■ FL-04600	772224 ■ FL-03800
			GRIP	772188 ■ FL-06700	-	-
		COOKIE MIX	COMFORT	772201 ■ FL-06700	772243 ■ FL-04600	772231 ■ FL-03800
			GRIP	772202 ■ FL-06700	-	-

		COLOR	SURFACE	120x280 47 ^{1/4"} x110 ^{1/4"}	120x240 47 ^{1/4"} x94 ^{1/2"}	120x120 47 ^{1/4"} x47 ^{1/4"}	60x120 23 ^{5/8"} x47 ^{1/4"}
MATCH-UP		COOKIE	COMFORT	772309 ■ FL-09100	772316 ■ FL-08400	772323 ■ FL-07000	772330 ■ FL-06700
			COMFORT	772312 ■ FL-09100	772319 ■ FL-08400	772326 ■ FL-07000	772333 ■ FL-06700
		COOKIE MIX	GLOSSY	772314 ■ FL-11900	772321 ■ FL-11300	772328 ■ FL-09300	772341 ■ FL-08600

MATCH-UP

EARL GREY



EARL GREY MIX



R10
CLASSE B
(comfort)

R11
CLASSE B
(grip)

DCOF>
0,42 Wet

BS EN 16165
ANNEX C
>36 Wet
slider 4S

9 mm 3/8" ↑↓



R10
CLASSE B
(comfort)

DCOF>
0,42 Wet
(comfort)

BS EN 16165
ANNEX C
>36 Wet
slider 4S
(comfort)

6 mm 1/4" ↑↓

FLORM OVERSIZE
magnUm

GRES FINE PORCELLANATO

FINE PORCELAIN STONEWARE/GRES CERAME FIN/FEINSTEINZEUG-KOLLEKTIONEN/GRES PORCELANICO FINO
SQUADRATO - SQUARED - EQUARRI - REKTIFIZIERT - ESCUADRADO

9 mm 3/8" ↑↓		COLOR	SURFACE	60x120 23 ^{5/8"} x47 ^{1/4"}	60x60 23 ^{3/8"} x23 ^{5/8"}	30x60 11 ^{4/5"} x23 ^{5/8"}
MATCH-UP		EARL GREY	COMFORT	772191 ■ FL-06700	772238 ■ FL-04600	772226 ■ FL-03800
			GRIP	772192 ■ FL-06700	-	-
		EARL GREY MIX	COMFORT	772205 ■ FL-06700	772245 ■ FL-04600	772233 ■ FL-03800
			GRIP	772206 ■ FL-06700	-	-

6 mm 1/4" ↑↓		COLOR	SURFACE	120x280 47 ^{1/4"} x110 ^{1/4"}	120x240 47 ^{1/4"} x94 ^{1/2"}	120x120 47 ^{1/4"} x47 ^{1/4"}	60x120 23 ^{5/8"} x47 ^{1/4"}
MATCH-UP		EARL GREY	COMFORT	772310 ■ FL-09100	772317 ■ FL-08400	772324 ■ FL-07000	772331 ■ FL-06700
			COMFORT	772313 ■ FL-09100	772320 ■ FL-08400	772327 ■ FL-07000	772340 ■ FL-06700
		EARL GREY MIX	GLOSSY	772315 ■ FL-11900	772322 ■ FL-11300	772329 ■ FL-09300	772342 ■ FL-08600

COFFEE



COFFEE MIX



R10
CLASSE B
(comfort)



R11
CLASSE B
(grip)

DCOF >
0,42 Wet

BS EN 16165
ANNEX C
>36 Wet
slider 4S

9 mm 3/8" ↑↓

GRES FINE PORCELLANATO
FINE PORCELAIN STONEWARE/GRES CERAME FIN/FEINSTEINZEUG-KOLLEKTIONEN/GRES PORCELANICO FINO
SQUADRATO - SQUARED - EQUARRI - REKTIFIZIERT - ESCUADRADO

				60x120 23 ^{5/8"} x47 ^{11/16"}	60x60 23 ^{5/8"} x23 ^{5/8"}	30x60 11 ^{4/5"} x23 ^{5/8"}
MATCH-UP		COFFEE	COMFORT	772189 ■ FL-06700	772237 ■ FL-04600	772225 ■ FL-03800
			GRIP	772190 ■ FL-06700	-	-
		COFFEE MIX	COMFORT	772203 ■ FL-06700	772244 ■ FL-04600	772232 ■ FL-03800
			GRIP	772204 ■ FL-06700	-	-

MATCH-UP

LIQUORICE



LIQUORICE MIX



V2
LIQUORICE

V3
LIQUORICE
MIX

R10
CLASSE B
(comfort)



R11
CLASSE B
(grip)

DCOF>
0,42 Wet

BS EN 16165
ANNEX C
>36 Wet
slider 4S

9 mm 3/8" ↑↓

GRES FINE PORCELLANATO
FINE PORCELAIN STONEWARE/GRES CERAME FIN/FEINSTEINZEUG-KOLLEKTIONEN/GRES PORCELANICO FINO
SQUADRATO - SQUARED - EQUARRI - REKTIFIZIERT - ESCUADRADO

9 mm 3/8" ↑↓		COLOR	SURFACE	60x120 23 ^{5/8"} x47 ^{1/4"}	60x60 23 ^{5/8"} x23 ^{5/8"}	30x60 11 ^{4/5"} x23 ^{5/8"}
MATCH-UP		LIQUORICE	COMFORT	772193 ■ FL-06700	772239 ■ FL-04600	772227 ■ FL-03800
			GRIP	772194 ■ FL-06700	-	-
		LIQUORICE MIX	COMFORT	772207 ■ FL-06700	772246 ■ FL-04600	772234 ■ FL-03800
			GRIP	772208 ■ FL-06700	-	-

BLUEBERRY



CINNAMON

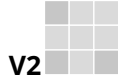

V2
R10
CLASSE B
 (comfort)



R11
CLASSE B
 (grip)

DCOF>
 0,42 Wet













BS EN 16165
 ANNEX C
 >36 Wet
 slider 4S

9 mm 3/8" ↑↓

GRES FINE PORCELLANATO
 FINE PORCELAIN STONEWARE/GRES CERAME FIN/FEINSTEINZEUG-KOLLEKTIONEN/GRES PORCELANICO FINO
 SQUADRATO - SQUARED - EQUARRI - REKTIFIZIERT - ESCUADRADO

				60x120 23 ^{5/8"} x47 ^{11/16"}	60x60 23 ^{5/8"} x23 ^{5/8"}	30x60 11 ^{4/5"} x23 ^{5/8"}
MATCH-UP		BLUEBERRY	COMFORT	772197 ■ FL-06700	772241 ■ FL-04600	772229 ■ FL-03800
			GRIP	772198 ■ FL-06700	-	-
		CINNAMON	COMFORT	772195 ■ FL-06700	772240 ■ FL-04600	772228 ■ FL-03800
			GRIP	772196 ■ FL-06700	-	-

MATCH-UP

9 mm 3/8" ↓	COLOR	SURFACE	30x30 11 4/5" x 11 4/5"  mosaico tessere 3x3 pz/box 11	0,5x60 1/4" x 23 5/8" matita inox pz/box 4 719674 ▲ FL-03100
	SUGAR	COMFORT	772264 ▲ FL-01600	
	SUGAR MIX	COMFORT	772271 ▲ FL-01600	
	COOKIE	COMFORT	772265 ▲ FL-01600	
	COOKIE MIX	COMFORT	772272 ▲ FL-01600	
	EARL GREY	COMFORT	772267 ▲ FL-01600	
	EARL GREY MIX	COMFORT	772274 ▲ FL-01600	
	COFFEE	COMFORT	772266 ▲ FL-01600	
	COFFEE MIX	COMFORT	772273 ▲ FL-01600	
	LIQUORICE	COMFORT	772268 ▲ FL-01600	
	LIQUORICE MIX	COMFORT	772275 ▲ FL-01600	
	BLUEBERRY	COMFORT	772270 ▲ FL-01600	
	CINNAMON	COMFORT	772269 ▲ FL-01600	

MATCH-UP













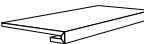



In relazione alle differenti tecnologie produttive l'accostamento di prodotti con spessori diversi potrebbe presentare delle disomogeneità, se ne sconsiglia pertanto l'abbinamento. / Due to the different production technologies, contiguous installation of products with different thickness may give a non-homogeneous result. For this reason we do not recommend this option. / Vu que différentes technologies de production sont utilisées avec des épaisseurs différentes, des problèmes d'homogénéité pourraient se présenter, il est donc déconseillé de les poser ensemble. / Wegen unterschiedlicher Produktionstechnologien können die Fliesen mit verschiedenen Materialstärken optische Differenzen aufweisen. Von einem direkten Aneinanderlegen wird deshalb abgeraten. / Dadas las diferentes tecnologías productivas, la combinación de productos de diferentes espesores podría dar lugar a heterogeneidad, por lo que se desaconseja mezclarlas.

Per un effetto ottimale della posa, florim suggerisce di mantenere 2 mm di fuga per pose monoformato e 3 mm per combinare formati misti. - For optimal installation results, florim recommends maintaining a joint of 2 mm 1/12" for single format installations and 3 mm 1/8" to combine mixed formats. - Pour réaliser une pose parfaite, florim suggère de maintenir 2 mm de joint pour la pose des monoformats, et 3 mm pour les combinaisons de formats mixtes. - Um einen optimalen effekt beim verlegen zu erzielen empfiehlt florim eine 2 mm fuge bei einformatigen verlegungen und 3 mm fuge bei formatkombinationen Para lograr los máximos resultados en la posa del producto, florim aconseja 2 mm de junta en aplicaciones monoformato y 3 mm en combinaciones de formatos mixtos.

Contemporary design

PEZZI SPECIALI/SPECIAL TRIMS/PIÈCES SPÉCIALES/FORMSTÜCKE/PIEZAS ESPECIALES









9 mm 3/8" ↑↓

	COLOR	SURFACE	4,6x60 1 4/5" x 23 5/8"  battiscopa	33x120x3 13" x 47 1/4" x 1 1/8"  gradino pz/box 2	33x120x3 13" x 47 1/4" x 1 1/8"  angolo gradino DX pz/box 2	33x120x3 13" x 47 1/4" x 1 1/8"  angolo gradino SX pz/box 2	
MATCH-UP		SUGAR	COMFORT	772251 ◆ FL-01600	772289 ▲ FL-20400	772276 ▲ FL-31100	772348 ▲ FL-31100
		SUGAR MIX	COMFORT	772258 ◆ FL-01600	772296 ▲ FL-20400	772283 ▲ FL-31100	772355 ▲ FL-31100
		COOKIE	COMFORT	772252 ◆ FL-01600	772290 ▲ FL-20400	772277 ▲ FL-31100	772349 ▲ FL-31100
		COOKIE MIX	COMFORT	772259 ◆ FL-01600	772297 ▲ FL-20400	772284 ▲ FL-31100	772356 ▲ FL-31100
		EARL GREY	COMFORT	772254 ◆ FL-01600	772292 ▲ FL-20400	772279 ▲ FL-31100	772351 ▲ FL-31100
		EARL GREY MIX	COMFORT	772261 ◆ FL-01600	772299 ▲ FL-20400	772287 ▲ FL-31100	772358 ▲ FL-31100
		COFFEE	COMFORT	772253 ◆ FL-01600	772291 ▲ FL-20400	772278 ▲ FL-31100	772350 ▲ FL-31100
		COFFEE MIX	COMFORT	772260 ◆ FL-01600	772298 ▲ FL-20400	772285 ▲ FL-31100	772357 ▲ FL-31100
		LIQUORICE	COMFORT	772255 ◆ FL-01600	772293 ▲ FL-20400	772280 ▲ FL-31100	772352 ▲ FL-31100
		LIQUORICE MIX	COMFORT	772262 ◆ FL-01600	772300 ▲ FL-20400	772288 ▲ FL-31100	772359 ▲ FL-31100
		BLUEBERRY	COMFORT	772257 ◆ FL-01600	772295 ▲ FL-20400	772282 ▲ FL-31100	772354 ▲ FL-31100
		CINNAMON	COMFORT	772256 ◆ FL-01600	772294 ▲ FL-20400	772281 ▲ FL-31100	772353 ▲ FL-31100







MATCH-UP	scatola - box			pallet		
	pz	mq	kg	box	mq	kg
60x120	2	1,44	28,08	30	43,20	870
60x60	3	1,08	21,49	40	43,20	890
30x60	6	1,08	21,49	40	43,20	890

MATCH-UP	scatola - box			pallet		
	pz	ml	kg	box	mq	kg
4,6x60 battiscopa	14	8,40	8,40	-	-	-

MATCH-UP

6 mm 1/4" ↑↓				30x30 11 4/5" x 11 4/5"  mosaico tessere 7,5x7,5 pz/box 11	30x30 11 4/5" x 11 4/5"  muretto tessere 7,5x15 pz/box 11
		COLOR	SURFACE		
MATCH-UP		SUGAR	COMFORT	772547 ▲ FL-01800	772556 ▲ FL-01800
		SUGAR MIX	COMFORT	772550 ▲ FL-01800	772559 ▲ FL-01800
			GLOSSY	772553 ▲ FL-02100	772562 ▲ FL-02100
		COOKIE	COMFORT	772548 ▲ FL-01800	772557 ▲ FL-01800
		COOKIE MIX	COMFORT	772551 ▲ FL-01800	772560 ▲ FL-01800
			GLOSSY	772554 ▲ FL-02100	772563 ▲ FL-02100
		EARL GREY	COMFORT	772549 ▲ FL-01800	772558 ▲ FL-01800
		EARL GREY MIX	COMFORT	772552 ▲ FL-01800	772561 ▲ FL-01800
			GLOSSY	772555 ▲ FL-02100	772564 ▲ FL-02100

PEZZI SPECIALI/SPECIAL TRIMS/PIÈCES SPÉCIALES/FORMSTÜCKE/PIEZAS ESPECIALES

6 mm 1/4" ↑↓				4,6x60 1 4/5" x 23 5/8"  battiscopa
		COLOR	SURFACE	
MATCH-UP		SUGAR	COMFORT	772566 ◆ FL-01800
		SUGAR MIX	COMFORT	772571 ◆ FL-01800
			GLOSSY	772574 ◆ FL-01800
		COOKIE	COMFORT	772569 ◆ FL-01800
		COOKIE MIX	COMFORT	772572 ◆ FL-01800
			GLOSSY	772575 ◆ FL-01800
		EARL GREY	COMFORT	772570 ◆ FL-01800
		EARL GREY MIX	COMFORT	772573 ◆ FL-01800
			GLOSSY	772576 ◆ FL-01800

FLORIM OVERSIZE
magnUm

120x280/120x240/120x120/60x120
 Specifica Imballo pag.
 Packaging specifications on page
 Spécifications d'emballage à page
 Verpackungsdetail Seite
 Especificaciones de embalaje a la página
158/159

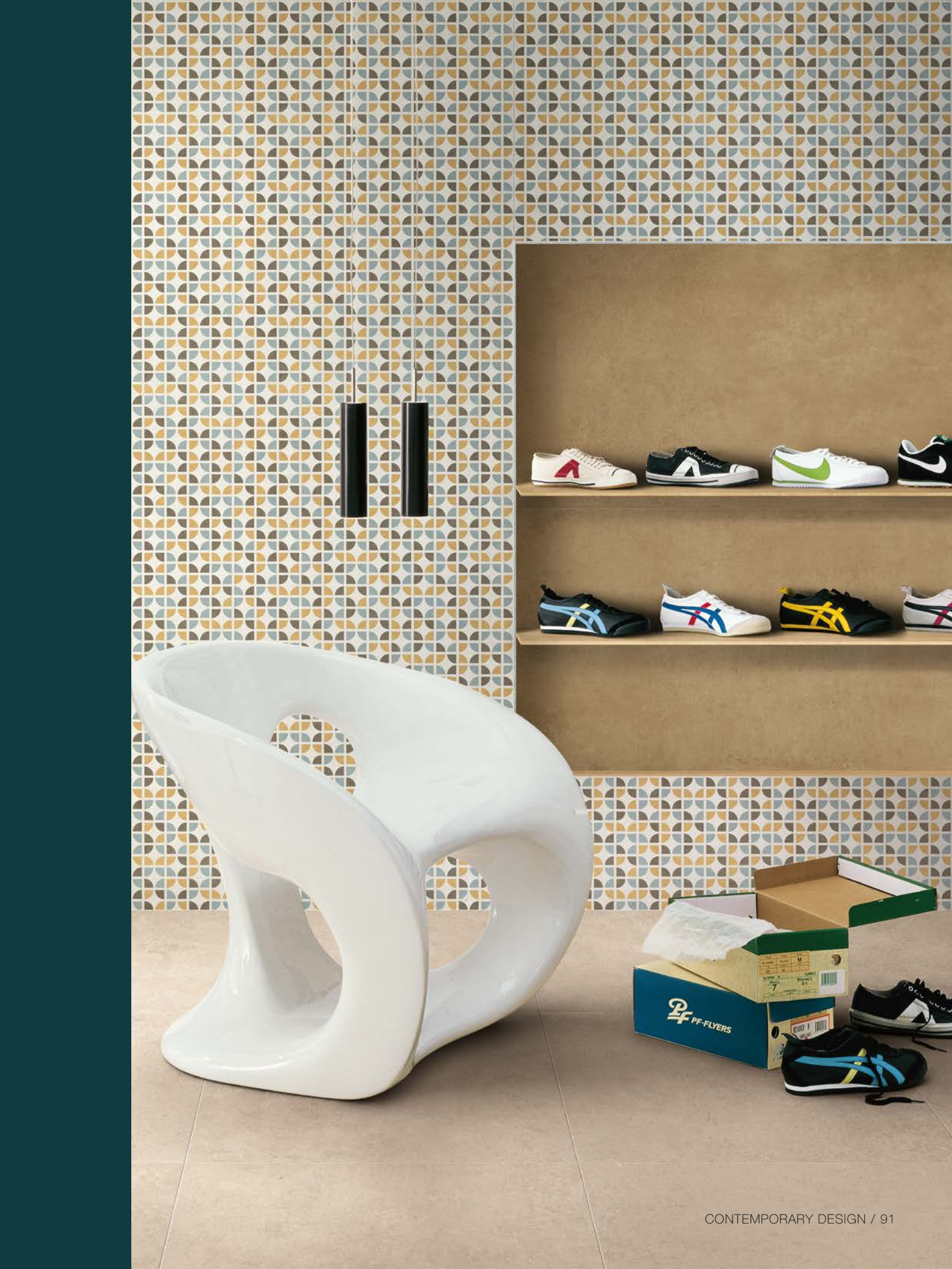

MATCH-UP

GRES PORCELLANATO SMALTATO

GLAZED PORCELAIN STONEWARE / GRES CÉRAMÉ ÉMAILLÉ / GLASIERTE FEINSTEINZEUG / GRES PORCÉLANICO ESMALTADO
SQUADRATO - SQUARED - EQUARRI - REKTIFIZIERT - ESCUADRADO





60x120
23^{5/8}"x47^{1/4}"



9 mm 3/8" ↑ ↓

120x280
47^{1/4}"x110^{1/4}"

6 mm 1/4" ↑ ↓

FLORIM OVERSIZE
magnUm

9 mm 3/8" ↑ ↓	COLOR	SURFACE	60x120 23 ^{5/8} "x47 ^{1/4} "
	WAVES	NATURALE/MATTE	772831 ■ FL-29000
MATCH-UP			
	TROPICO	NATURALE/MATTE	772835 ■ FL-29000

6 mm 1/4" ↑ ↓	COLOR	SURFACE	120x280 47 ^{1/4} "x110 ^{1/4} "
	WAVES	NATURALE/MATTE	772823 ■ FL-31100
MATCH-UP			
	TROPICO	NATURALE/MATTE	772834 ■ FL-31100

FLORIM OVERSIZE
magnUm

120x280
Specifica Imballo pag.
Packaging specifications on page
Spécifications d'emballage à page
Verpackungsdetail Seite
Especificaciones de embalaje a la página
158/159

MATCH-UP	scatola - box			pallet		
	pz	mq	kg	box	mq	kg
60x120 DECORO	2	1,44	28,08	20	28,80	590

Ogni soggetto è caratterizzato da una decorazione che continua da pezzo a pezzo considerando 2mm di fuga. Prima di passare alla fase di posa stendere i vari soggetti a terra per verificarne la continuità del prodotto. / Each panel features a pattern that continues from piece to piece with a 2 mm joint. Before laying, spread the various panels on the ground to check the pattern's continuity. / Chaque sujet se caractérise par une décoration qui continue d'une pièce à l'autre, en tenant compte de 2 mm de joint. Avant de passer à la phase de pose, étaler les différents sujets au sol, pour en vérifier la continuité de la décoration. / Jedes Muster ist von einem Dekor charakterisiert, das von Platte zu Platte weiterverläuft, wenn man von der 2 mm Fuge absieht. Sollte vor dem Verlegen die einzelnen Muster auf den Boden angeordnet werden, um die Kontinuität des Dekors zu prüfen. / Cada pieza se caracteriza por una decoración que continúa de una a otra con una fuga de 2 mm. Antes de pasar a la fase de colocación extender los diferentes motivos sobre el suelo para comprobar la continuidad de la decoración.

DECORO WAVES

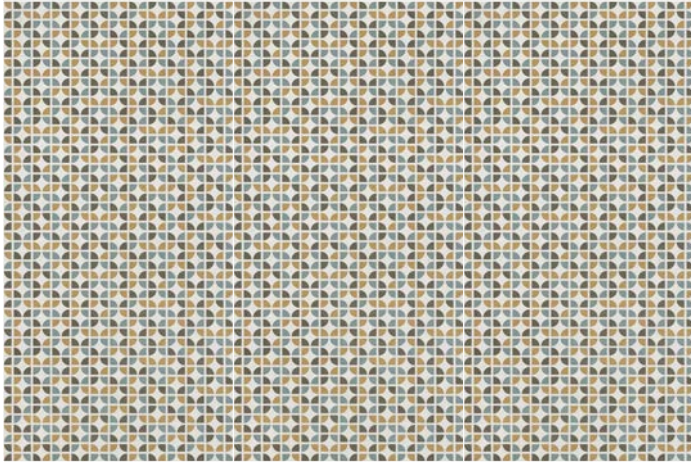

DECORO TROPICO



GRES PORCELLANATO SMALTATO GLAZED PORCELAIN STONEWARE - GRES CÉRAMÉ ÉMAILLÉ - GLASIERTE FEINSTEINZEUG - GRES PORCÉLANICO ESMALTADO					
Caratteristiche di qualità secondo i tests di controllo previsti dalle norme EN 14411-ISO 13006 appendice G gruppo B1a GL / Quality characteristics according to the inspection tests envisaged by standard EN 14411-ISO 13006 appendix G group B1a GL / Caractéristiques de qualité selon les tests de contrôle prévus par les normes EN 14411-ISO 13006 appendice G groupe B1a GL / Qualitätseigenschaften gemäß den Kontrolltests der Normen EN 14411-ISO 13006, Anhang G Gruppe B1a GL / Características de calidad según los ensayos previstos por las normas EN 14411-ISO 13006-adjencia G grupo B1a GL	PRESCRIZIONE STANDARD REQUIREMENTS PRESCRIPTIONS / ANFORDERUNGEN PRESCRIPCION	RISULTATI TESTS TEST RESULTS / RESULTATS DES ESSAIS PRÜFERGEBNIS / RESULTADOS TESTS	RIFERIMENTO NORMA REFERENCE STANDARD RÉFÉRENCE NORME STANDARDWERT REFERENCIA NORMA		
	N ≥ 15 cm (%) (mm)	Naturale/Matte			
Lunghezza e larghezza (deviazione ammissibile dalla dimensione di fabbricazione) / Length and width (admitted tolerance from factory size) / Longueur et largeur (tolérance admissible de la dimension de fabrication) / Länge und Breite (zulässige Abweichung von den fabriktionsabmessungen) / Longitud y anchura (desviación admisible respecto al tamaño de fabricación)	Squadrato ISO 13006	±0,3%	±1,0mm	±0,15%	
Spessore: deviazione dello spessore medio di ogni piastrella dalle dimensioni di fabbricazione in % / Thickness: average thickness tolerance, in % versus production dimension / Epaisseur: écart de l'épaisseur moyenne pour chaque carreau par rapport aux dimensions de fabrication en % / Dicke: abweichung der vom hersteller angegebenen stärke in % / Espesor: desviación del espesor medio de cada azulejo respecto a las medidas de fabricación en %	-	±5%	±0,5mm	±5%	
Rettilinearità degli spigoli/Straightness of edges / Rectitude des bords / Geradlinigkeit der Kanten / Rectitud de las aristas	Squadrato ISO 13006	±0,3%	±0,8mm	±0,1%	ISO 10545-2
Ortogonalità in % / Orthogonalité en % / Rechtwinkeligkeit in % / Ortogonalidad en %	Squadrato ISO 13006	±0,3%	±1,5mm	±0,2%	
Planarità (curvatura del centro, dello spigolo e svergolamento)/Flatness (curving in the middle, corner and warping) Planéité (courbure centrale, de l'arête et gauchissement)/Ebenflächigkeit (krümmung der mitte, der kante und verwindung) Planitud (curvatura del centro, de la arista y abarquillamiento)	Squadrato ISO 13006	±0,4 %	±1,8mm	±0,35%	
Qualità della superficie Surface quality / Qualité de la surface / Oberflächenqualität Calidad de la superficie de acabado	Il 95% min della piastrelle deve essere esente da difetti visibili. / At least 95% of the tiles must be free from visible flaws. 95% min des carreaux ne doivent présenter aucun défaut visible. Mindestens 95% der Fliesen müssen frei von sichtbaren min. El 95% de las baldosas tiene que estar exento de defectos visibles			CONFORME/CONFORMING CONFORME/KONFORM CONFORME	
Massa d'acqua assorbita in % % Water absorption / Masse d'eau absorbée en % / Wasseraufnahme in % Masa de agua absorbida en %		E≤0,5%		valore medio 0,08%	ISO 10545-3
Forza di rottura in N (spessore ≥ 7,5 mm) / Rupture force in N (thickness ≥ 7,5 mm) / Force de rupture en N (ép. ≥ 7,5 mm) Bruchkraft in N (dicke ≥ 7,5 mm) / Fuerza de rotura en N (gr. ≥ 7,5 mm)		1300 min		valore medio 2200 N spessore 9mm	ISO 10545-4
Forza di rottura in N (spessore < 7,5 mm) - Breaking strength in N (thickness < 7,5 mm) - Force de rupture en N (ép.< 7,5 mm) - Bruchkraft in N (dicke < 7,5 mm) - Fuerza de rotura en N (gr. < 7,5 mm)		≥ 700		valore medio 1350 N spessore 6mm	ISO 10545-4
Resistenza alla flessione in N/mm2 Bending strength N/mm2 / Résistance à la flexion N/mm2 Biegefestigkeit in N/mm2 / Resistencia a la flexion en N/mm2		35 min		valore medio 50N/mm2 spessore 9mm valore medio 52N/mm2 spessore 6mm	ISO 10545-4
Resistenza all'abrasione Resistance to abrasion / Résistance à l'abrasion / Abriebfest Resistencia a la abrasión		come dichiarato dal produttore / see manufacturer's declaration / selon déclaration du producteur / entsprechend der herstellereangaben / tal como declaró el fabricante		Classe 3	ISO 10545-7
Resistenza alle macchie Resistance to staining / Résistance aux taches / Fleckenabweisend Resistencia a las manchas		Classe 3 min		Classe 5	ISO 10545-14
Resistenza agli sbalzi termici / Thermal shocks resistant Résistance aux variations thermiques / Temperaturwechselbeständigkeit Resistencia al choque térmico		-		Resiste - Résistant Resiste - Erfüllt Resiste	ISO 10545-9
Resistenza ai prodotti chimici di uso domestico ed additivi per piscine / Resistance to house and swimming pool chemicals / Résistance aux produits d'emploi domestiques et additifs pour piscines / Widerstand gegen Haushaltschemikalien, Badewasserszusätze / Resistencia a los productos químicos de uso doméstico y aditivos para piscinas		Classe B min		GA	ISO 10545-13
Resistenza a basse concentrazioni di acidi e alcali. / Resistance to low concentrations of acids and alkalis. / Résistance a basses concentrations d'acides et alcalis. / Widerstand gegen niedrige konzentrationen von sauren und laugen. Resistencia a bajas concentraciones de acidos y alcalis.		come dichiarato dal produttore / see manufacturer's declaration / selon déclaration du producteur / entsprechend der herstellereangaben / tal como declaró el fabricante		GLA	ISO 10545-13
Resistenza al gelo - frost resistance résistance au gel - frostsicherheit resistencia a la helada		Richiesta / Required / Requisite / Gefordert Requerida		Resiste - Résistant Resiste - Erfüllt Resiste	ISO 10545-12
Coefficiente d'attrito (scivolosità) - friction coefficient (slipperiness) - coefficient de friction (glissement) reibungskoeffizient (schlupfrigkeit) - coeficiente de anti deslizamiento		-		>0,42 WET	DCOF (section 9.6 ANSI A 137.1 2012) DIN EN 16165 ANNEX B
		-		R9	

MATCH-UP

GRES FINE PORCELLANATO

FINE PORCELAIN STONEWARE/GRES CERAME FIN/FEINSTEINZEUG-KOLLEKTIONEN/GRES PORCELANICO FINO
SQUADRATO - SQUARED - EQUARRI - REKTIFIZIERT - ESCUADRADO

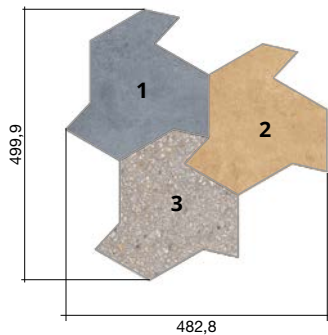

DECORO SHAPES **772836**

- 1) BLUEBERRY
- 2) CINNAMON
- 3) EARL GREY MIX

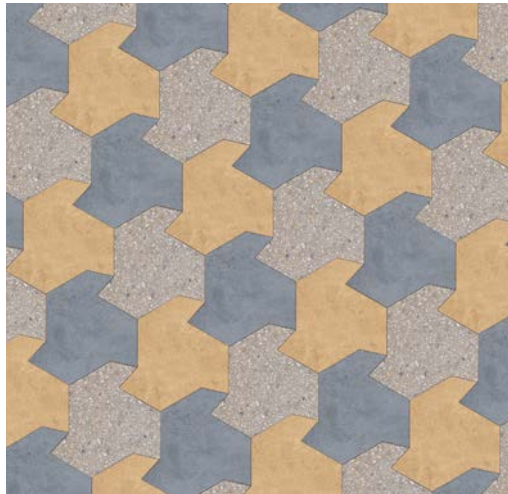

Il decoro SHAPES è disponibile a magazzino nei colori EARL GREY MIX+CINNAMON+BLUEBERRY / The SHAPES décor is available in stock in the colours EARL GREY MIX+CINNAMON+BLUEBERRY. / Le décor SHAPES est disponible en stock dans les couleurs EARL GREY MIX+CINNAMON+BLUEBERRY. / Der Dekor SHAPES ist in den Farben EARL GREY MIX+CINNAMON+BLUEBERRY als Lagerware bestellbar. / La decoración SHAPES está disponible en stock en los colores EARL GREY MIX+CINNAMON+BLUEBERRY.

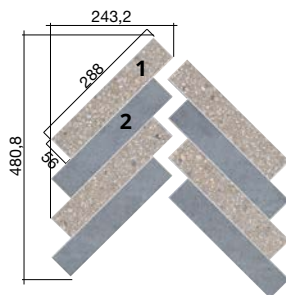

DECORO ZIG ZAG **772838**

- 1) EARL GREY MIX
- 2) BLUEBERRY



Il decoro ZIG ZAG è disponibile a magazzino nei colori EARL GREY MIX+BLUEBERRY / The ZIG ZAG décor is available in stock in the colours EARL GREY MIX+BLUEBERRY. / Le décor ZIG ZAG est disponible en stock dans les couleurs EARL GREY MIX+BLUEBERRY. / Der Dekor ZIG ZAG ist in den Farben EARL GREY MIX+BLUEBERRY als Lagerware bestellbar. / La decoración ZIG ZAG está disponible en stock en los colores EARL GREY MIX+BLUEBERRY

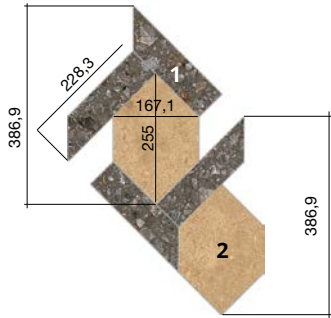

DECORO LOCK **772840**
1) COFFEE MIX
2) CINNAMON



Il decoro LOCK è disponibile a magazzino nei colori COFFEE MIX+CINNAMON / The LOCK décor is available in stock in the colours COFFEE MIX+CINNAMON. / Le décor LOCK est disponible en stock dans les couleurs COFFEE MIX+CINNAMON. / Der Dekor LOCK ist in den Farben COFFEE MIX+CINNAMON als Lagerware bestellbar. / La decoración LOCK está disponible en stock en los colores COFFEE MIX+CINNAMON.

9 mm 3/8" ↑↓			SURFACE	ON DEMAND*	
MATCH-UP		DECORO SHAPES	COMFORT	772836 ■ FL-29000	772837 ■ FL-49300
		DECORO ZIG ZAG	COMFORT	772838 ■ FL-29000	772839 ■ FL-36500
		DECORO LOCK	COMFORT	772840 ■ FL-29000	772841 ■ FL-49300

6 mm 1/4" ↑↓			SURFACE	ON DEMAND*
MATCH-UP		DECORO SHAPES	COMFORT	774073 ■ FL-58900
		DECORO ZIG ZAG	COMFORT	774074 ■ FL-47100
		DECORO LOCK	COMFORT	774049 ■ FL-58900

MATCH-UP	scatola - box			pallet		
	pz	mq	kg	box	mq	kg
DECORO SHAPES 9mm	6	0,80	17,84	20	16	390
DECORO ZIG-ZAG 9mm	6	0,39	8,63	60	23,22	550
DECORO LOCK 9mm	6	0,33	7,36	40	13,20	320

MATCH-UP	scatola - box			pallet		
	pz	mq	kg	box	mq	kg
DECORO SHAPES ON DEMAND 9mm	6	0,27	6,02	36	9,72	250
DECORO ZIG-ZAG ON DEMAND 9mm	6	0,39	8,63	16	6,19	170
DECORO LOCK ON DEMAND 9mm	6	0,33	7,36	16	5,28	150

MATCH-UP	scatola - box			pallet		
	pz	mq	kg	box	mq	kg
DECORO SHAPES ON DEMAND 6mm	8	0,36	5,21	36	12,96	210
DECORO ZIG-ZAG ON DEMAND 6mm	8	0,52	7,53	16	8,32	140
DECORO LOCK ON DEMAND 6mm	8	0,44	12,74	16	7,04	220

***I restanti colori sono ordinabili su richiesta tramite i codici on demand della tabella, scegliendo colori e finiture nel modo in cui si desidera. / The remaining colours can be ordered on request using the "on demand" codes in the table, specifying the desired colours and finishes. / Les autres couleurs peuvent être commandées sur demande avec les codes spécifiques du tableau en pièce jointe, en indiquant les couleurs et les finitions que l'on souhaite. / Die restlichen Farben können auf Anfrage über die On-Demand-Codes der Tabelle bestellt werden, wobei Farben und Oberflächen nach Ihren Wünschen ausgewählt werden. / El resto de colores se pueden pedir a través de los códigos de la tabla, eligiendo colores y acabados como desee.**

MATCH-UP OUTDOOR

Vantaggi tecnici - Technical advantages - Avantages techniques Technische Vorteile - Ventajas técnicas

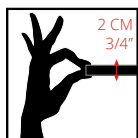

- Lastra monolitica compatta di spessore 2 cm squadrata e rettificata
- Compact monolithic slab 2 cm thick squared and rectified
- Dalle monolithique compacte de 2 cm d'épaisseur, équaree et rectifiée
- Kompakte monolithische Platte, 2 cm dick, rechteckig und scharfkantig geschliffen
- Losa monolítica compacta de 2 cm de espesor, escuadrada y rectificada.

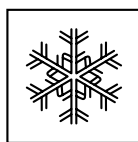

- INGELIVO
- FROST RESISTANT
- INGÉLIF
- FROSTBESTÄNDIG
- RESISTENTE A LA HELADA



- ELEVATA RESISTENZA AI CARICHI STATICI
- HIGH STATIC LOAD RESISTANCE
- RÉSISTANCE ÉLEVÉE AUX CHARGES STATIQUES
- HOHE STATISCHE BELASTBARKEIT
- ELEVADA RESISTENCIA A LAS CARGAS ESTÁTICAS

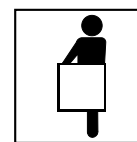

- FACILE DA POSARE
- EASY TO INSTALL
- FACILE À POSER
- VERLEGELEICHT
- FÁCIL DE COLOCAR



- ANTISCIVOLO R11
- ANTI SLIP R11
- ANTIDÉRAPANT R11
- RUTSCHFEST R11
- ANTIDESLIZANTE R11

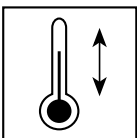

- RESISTENTE AGLI SBALZI TERMICI
- THERMAL SHOCK RESISTANT
- RÉSISTANT AUX ÉCARTS THERMIQUES
- TEMPERATURWECHSELBESTÄNDIG
- RESISTENTE A LAS OSCILACIONES TÉRMICAS



- FACILE DA PULIRE
- EASY TO CLEAN
- FACILE À NETTOYER
- REINIGUNGSLEICHT
- FÁCIL DE LIMPIAR

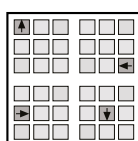

- RIMOVIBILE E RIUTILIZZABILE
- REMOVABLE AND REUSABLE
- DÉMONTABLE ET RÉUTILISABLE
- ENTFERNBAR UND WIEDERVERWENDBAR
- DESMONTABLE Y REUTILIZABLE



- INATTACCABILE DA AGENTI CHIMICI E MUFFE
- IMPERVIOUS TO ATTACK BY CHEMICALS OR MOULD
- RÉSISTANT AUX AGENTS CHIMIQUES ET AUX MOISSISSURES
- UNANGREIFBAR DURCH CHEMISCHE STOFFE UND SCHIMMEL
- RESISTENTE A LOS AGENTES QUÍMICOS Y A LOS MOHOS

Applicazioni - Applications - Applications - Verlegung - Aplicaciones

- Posa diretta su erba
- Direct installation on grass
- Pose direct sur de l'herbe
- Verlegung direkt auf Rasen
- Colocación directa sobre hierba



- Posa diretta su ghiaia
- Direct installation over gravel
- Pose direct sur du gravier
- Verlegung direkt auf Kies
- Colocación directa sobre grava



- Posa su massetto cementizio
- Installation on sand-cement screed
- Pose sur chape ciment
- Verlegung auf Zement-Unterbetonblock
- Colocación sobre contrapiso de hormigón

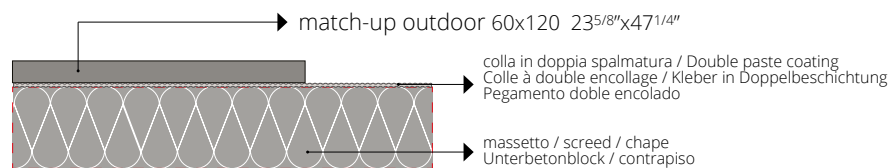

- Posa su piedini fissi o regolabili
- Installation on fixed or adjustable feet
- Pose sur pieds fixes ou réglables
- Verlegung auf feststehende oder regulierbare Füße
- Colocación sobre pies fijos o regulables

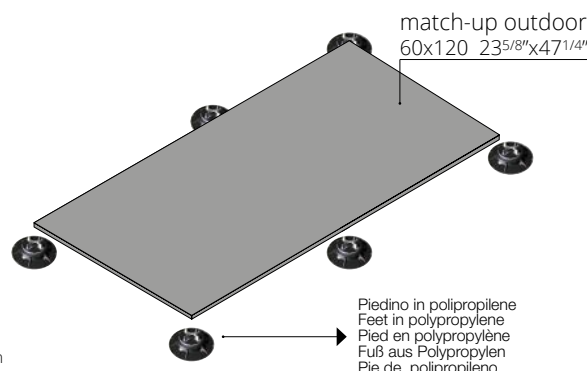

Per le specifiche di utilizzo dei sistemi sopraelevati vedi il sito florim.com
For the specifics on use of raised systems visit the site florim.com
Pour les caractéristiques d'utilisation des systèmes surélevés, voir le site florim.com
Für die Nutzungsbedingungen der Doppelbodensysteme siehe Webseite florim.com
Para las especificaciones de empleo de los sistemas sobreelevados consulte el sitio web florim.com

Le lastre ceramiche sono sottoposte a un trattamento di compattazione termica che assicura resistenza e durata nel tempo. Il bassissimo assorbimento d'acqua rende perciò il materiale ingelivo. Ciò può comportare ristagni d'acqua superficiali anche per materiale installato a regola d'arte. / Ceramic tiles undergo a compacting thermal treatment that ensures resistance and durability. The low level of water absorption makes the slabs frost resistant. This could result in superficial water stagnations even if materials are installed in a workmanlike manner. / Les carreaux de céramique subissent un traitement thermique de compactage qui assure résistance et durabilité. Le bas niveau d'absorption d'eau rend les dalles résistant au gel. Il pourrait en résulter des stagnations d'eau superficielles, même si les dalles ont été installées dans les règles de l'art. / Die Keramikplatten werden einer thermischen Verdichtung unterzogen, welche die Widerstandsfähigkeit und Langlebigkeit sichert. Die extrem niedrige Wasseraufnahme macht das Material frostsicher. Die hohe Materialdichte kann, auch bei einer perfekten Verlegung, eine längere Abtrochnungszeit von angestaumtem Wasser zur Folge haben. / Las baldosas cerámicas se someten a un tratamiento de compactación térmica que asegura resistencia y durabilidad. La baja absorción de agua hace que las baldosas resistan al hielo. Esto podría resultar en estancamientos superficiales de agua, incluso si los materiales están instalados según las reglas del arte.

SUGAR



SUGAR MIX

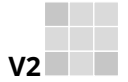

**R11
CLASSE C**

DCOF>
0,42 Wet

BS EN 16165
ANNEX C
>36 Wet
slider 4S

20 mm 3/4" ↑↓

COOKIE



COOKIE MIX



EARL GREY









EARL GREY MIX



GRES FINE PORCELLANATO

FINE PORCELAIN STONEWARE/GRES CERAME FIN/FEINSTEINZEUG-KOLLEKTIONEN/GRES PORCELANICO FINO
SQUADRATO - SQUARED - EQUARRI - REKTIFIZIERT - ESCUADRADO

20 mm 3/4" ↑↓

	COLOR	SURFACE	60x120 23 ^{31/32"} x47 ^{1/4"}
	SUGAR	GRIP	772150 ■ FL-09100
	SUGAR MIX	GRIP	772156 ■ FL-09100
	COOKIE	GRIP	772152 ■ FL-09100
	COOKIE MIX	GRIP	772157 ■ FL-09100
	EARL GREY	GRIP	772155 ■ FL-09100
	EARL GREY MIX	GRIP	772158 ■ FL-09100

MATCH-UP



Product Certification
BUREAU VERITAS
Certification

Recycled material content certification

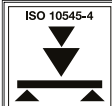
ISO 10545-4	RESISTENZA ALLA FLESSIONE IN N/mm ² N/mm ² FLEXURAL STRENGTH TEST / RESISTANCE A LA FLEXION EN N/mm ² / BIEGEFESTIGKEIT IN N/mm ² / RESISTENCIA A LA FLEXION EN N/mm ²	valore medio 52 N/mm ²
	Forza di rottura in N (sp. > 7,5 mm) Breaking strength in N (thickness > 7,5 mm) / Force de rupture en N (esp. > 7,5 mm) / Bruchlast in N (Dicke > 7,5 mm) / Fuerza de rotura en N (gr. > 7,5 mm)	valore medio 14000 N

PEZZI SPECIALI

Special trims/Pièces spéciales/Formstücke
Piezas especiales
pag 150-151

MATCH-UP	scatola - box			pallet		
	pz	mq	kg	box	mq	kg
60x120 20mm	1	0,72	32,26	30	21,60	1000



NATURAL STONE

gres porcellanato smaltato
glazed porcelain stoneware
gres cérame émaillé
glasierte Feinsteinzeug
gres Porcelánico esmaltado





NATURA
LE
ALESSANDRO ROCCA

NATURAL STONE

Eleganza è attenzione ai dettagli e **Natural Stone** nasce da questo presupposto. Ripropone il sapore antico delle ardesie provenienti dai paesi del nord con coerenza e una sinuosa armonia cromatica. Rivela il racconto del tempo e il suo susseguirsi infinito, rappresenta la straordinaria forza della natura e la sua sorprendente semplicità estetica evocando una sobria raffinatezza figlia della modernità.

Elegance is attention to detail and **Natural Stone** stems from this assumption. It revisits the ancient taste of slates coming from northern lands, with consistency and sinuous, chromatic harmony. It reveals the story of time and its infinite passage, and represents the extraordinary force of nature and her amazing aesthetic simplicity, evoking a sober elegance, the daughter of modernity.

L'élégance, c'est prendre soin des détails. **Natural Stone** naît de ce principe, et repropose la saveur ancienne des ardoises provenant des pays nordiques, où l'on retrouve cohérence et harmonie chromatique sinueuse. Cette collection est l'histoire du temps et de son passage sans fin. Elle représente l'extraordinaire force de la nature et sa surprenante simplicité esthétique à travers l'évocation d'un sobre raffinement, enfant de la modernité.

Eleganz bedeutet Beachtung des Details und **Natural Stone** entstand auf der Grundlage dieser Voraussetzung. Hier kommt der antike Geschmack der nordländischen Steinschiefer zum Tragen, konsequent und in anmutiger Farbharmonie ausgeführt. Natural Stone erzählt die Geschichte in ihrer Unendlichkeit, spiegelt die außergewöhnliche Kraft der Natur und ihre überraschend einfache Ästhetik wider und überzeugt durch das gleichzeitig schlicht raffinierte und moderne Design.

Elegancia significa prestar atención a los detalles, y **Natural Stone** parte de este presupuesto. Replantea el gusto antiguo de las pizarras procedentes de los países nórdicos con coherencia y una sinuosa armonía cromática. Revela la historia del tiempo y su fluir infinito, representa la fuerza extraordinaria de la naturaleza y su sorprendente sencillez estética, evocando un sobrio refinamiento producto de la modernidad.

NATURAL STONE

WHITE



CREAM

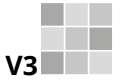

R10
CLASSE B



R11
(grip)

DCOF>
0,42 Wet

9 mm 3/8" ↑↓

GRES PORCELLANATO SMALTATO

GLAZED PORCELAIN STONEWARE / GRES CÉRAMÉ ÉMAILLÉ / GLASIERTE FEINSTEINZEUG / GRES PORCELÁNICO ESMALTADO
SQUADRATO - SQUARED - EQUARRI - REKTIFIZIERT - ESCUADRADO

9 mm 3/8" ↑↓		COLOR	SURFACE	60x120 23 ^{5/8"} x47 ^{1/4"}	60x60 23 ^{5/8"} x23 ^{5/8"}	30x60 11 ^{4/5"} x23 ^{5/8"}
NATURAL STONE		WHITE	NATURALE	752006 ■ FL-06500	752010 ■ FL-04600	752014 ■ FL-03800
			GRIP	-	-	752019 ■ FL-03800
		CREAM	NATURALE	753000 ■ FL-06500	753003 ■ FL-04600	752997 ■ FL-03800
			GRIP	-	-	753005 ■ FL-03800

FOSSIL



MINERAL



V3
R10
CLASSE B

R11
(grip)

DCOF>
0,42 Wet

9 mm 3/8" ↑

GRES PORCELLANATO SMALTATO

GLAZED PORCELAIN STONEWARE / GRES CÉRAMÉ ÉMAILLÉ / GLASIERTE FEINSTEINZEUG / GRES PORCÉLANICO ESMALTADO
SQUADRATO - SQUARED - EQUARRI - REKTIFIZIERT - ESCUADRADO

			9 mm 3/8" ↑		
	COLOR	SURFACE	60x120 23 ^{5/8"} x47 ^{1/4"}	60x60 23 ^{5/8"} x23 ^{5/8"}	30x60 11 ^{4/5"} x23 ^{5/8"}
NATURAL STONE	FOSSIL	NATURALE	752007 ■ FL-06500	752011 ■ FL-04600	752015 ■ FL-03800
		GRIP	-	-	752020 ■ FL-03800
	MINERAL	NATURALE	752008 ■ FL-06500	752012 ■ FL-04600	752016 ■ FL-03800
		GRIP	-	-	752021 ■ FL-03800

NATURAL STONE

COAL

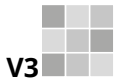
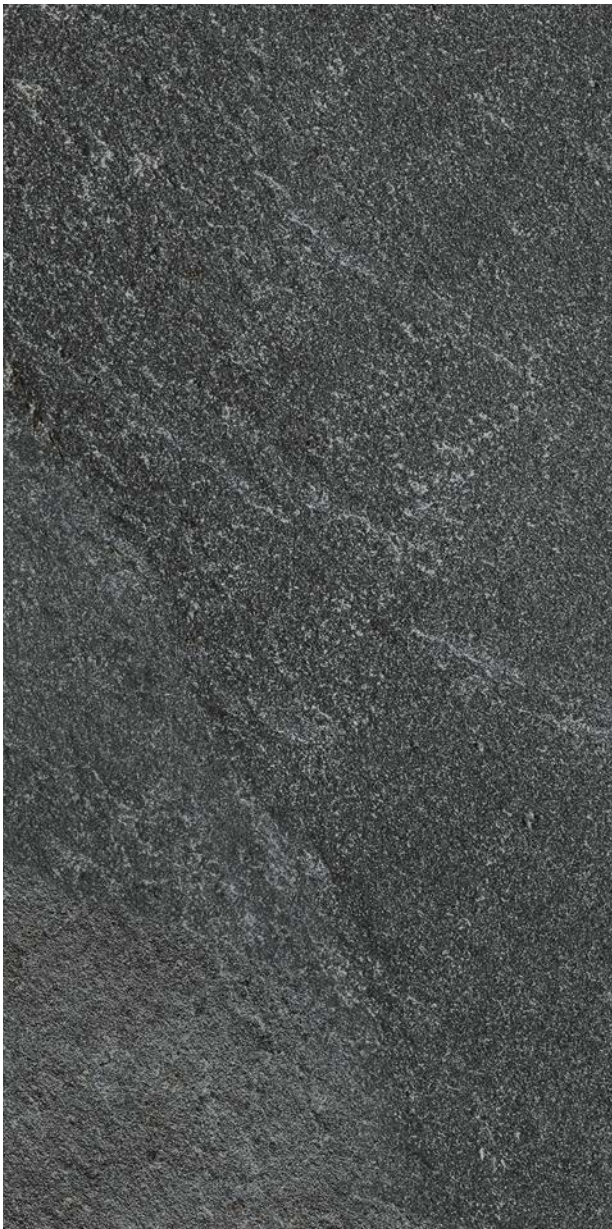

V3

R10
CLASSE B

R11
(grip)







DCOF>
0,42 Wet

9 mm 3/8" ↑↓

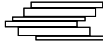





GRES PORCELLANATO SMALTATO

GLAZED PORCELAIN STONEWARE / GRES CÉRAMÉ ÉMAILLÉ / GLASIERTE FEINSTEINZEUG / GRES PORCÉLANICO ESMALTADO
SQUADRATO - SQUARED - EQUARRI - REKTIFIZIERT - ESCUADRADO

9 mm 3/8" ↑↓	COLOR	SURFACE	60x120	60x60	30x60
			23 ^{5/8"} x47 ^{11/16"}	23 ^{5/8"} x23 ^{5/8"}	11 ^{4/5"} x23 ^{5/8"}
NATURAL STONE	COAL	NATURALE	752009 ■ FL-06500	752013 ■ FL-04600	752018 ■ FL-03800
		GRIP	-	-	752022 ■ FL-03800

9 mm 3/8" ↑↓		COLOR	SURFACE	21x40 8 1/4" x 15 3/4"  modulo listello sfalsato pz/box 5
NATURAL STONE		WHITE	NATURALE	753112 ▲ FL-01600
		CREAM	NATURALE	753114 ▲ FL-01600
		FOSSIL	NATURALE	753115 ▲ FL-01600
		MINERAL	NATURALE	753116 ▲ FL-01600
		COAL	NATURALE	753117 ▲ FL-01600

PEZZI SPECIALI/SPECIAL TRIMS/PIÈCES SPÉCIALES/FORMSTÜCKE/PIEZAS ESPECIALES

9 mm 3/8" ↑↓		COLOR	SURFACE	4,6x60 1 4/5" x 23 5/8"  battiscopa
NATURAL STONE		WHITE	NATURALE	753118 ◆ FL-01600
		CREAM	NATURALE	753120 ◆ FL-01600
		FOSSIL	NATURALE	753121 ◆ FL-01600
		MINERAL	NATURALE	753122 ◆ FL-01600
		COAL	NATURALE	753123 ◆ FL-01600



Per un effetto ottimale della posa, florim suggerisce di mantenere 2 mm di fuga per pose monoformato e 3 mm per combinare formati misti - For optimal installation results, florim recommends maintaining a joint of 2 mm 1/16" for single format installations and 3 mm 1/8" to combine mixed formats. - Pour réaliser une pose parfaite, florim suggère de maintenir 2 mm de joint pour la pose des monoformats, et 3 mm pour les combinaisons de formats mixtes. - Um einen optimalen effekt beim verlegen zu erzielen empfiehlt florim eine 2 mm fugel bei einformatigen verlegungen und 3 mm fugel bei formatkombinationen Para lograr los máximos resultados en la posad del producto, florim aconseja 2 mm de junta en aplicaciones monoformato y 3 mm en combinaciones de formatos mixtos

NATURAL STONE	scatola - box			pallet		
	pz	mq	kg	box	mq	kg
60x120	2	1,44	28,08	30	43,20	870
60x60	3	1,08	21,49	40	43,20	890
30x60	6	1,08	21,49	40	43,20	890

NATURAL STONE	scatola - box			pallet		
	pz	ml	kg	box	mq	kg
4,6x60 battiscopa	14	8,40	8,40	-	-	-

NATURAL STONE OUTDOOR

Vantaggi tecnici - Technical advantages - Avantages techniques Technische Vorteile - Ventajas técnicas

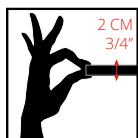

- Lastra monolitica compatta di spessore 2 cm squadrata e rettificata
- Compact monolithic slab 2 cm thick squared and rectified
- Dalle monolithique compacte de 2 cm d'épaisseur, égarrie et rectifiée
- Kompakte monolithische Platte, 2 cm dick, rechteckig und scharfkantig geschliffen
- Losa monolítica compacta de 2 cm de espesor, esquadrada y rectificada.

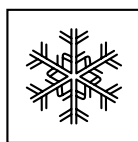

- INGELIVO
- FROST RESISTANT
- INGÉLIF
- FROSTBESTÄNDIG
- RESISTENTE A LA HELADA



- ELEVATA RESISTENZA AI CARICHI STATICI
- HIGH STATIC LOAD RESISTANCE
- RÉSISTANCE ÉLEVÉE AUX CHARGES STATIQUES
- HOHE STATISCHE BELASTBARKEIT
- ELEVADA RESISTENCIA A LAS CARGAS ESTÁTICAS

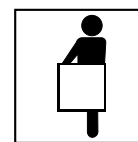

- FACILE DA POSARE
- EASY TO INSTALL
- FACILE À POSER
- VERLEGELEICHT
- FÁCIL DE COLOCAR



- ANTISCIVOLO R11
- ANTI SLIP R11
- ANTIDÉRAPANT R11
- RUTSCHFEST R11
- ANTIDESLIZANTE R11

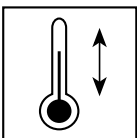

- RESISTENTE AGLI SBALZI TERMICI
- THERMAL SHOCK RESISTANT
- RÉSISTANT AUX ÉCARTS THERMIQUES
- TEMPERATURWECHSELBESTÄNDIG
- RESISTENTE A LAS OSCILACIONES TÉRMICAS



- FACILE DA PULIRE
- EASY TO CLEAN
- FACILE À NETTOYER
- REINIGUNGSLEICHT
- FÁCIL DE LIMPIAR

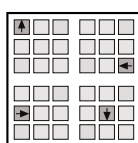

- RIMOVIBILE E RIUTILIZZABILE
- REMOVABLE AND REUSABLE
- DÉMONTABLE ET RÉUTILISABLE
- ENTFERNBAR UND WIEDERVERWENDBAR
- DESMONTABLE Y REUTILIZABLE



- INATTACCABILE DA AGENTI CHIMICI E MUFFE
- IMPERVIUOUS TO ATTACK BY CHEMICALS OR MOULD
- RÉSISTANT AUX AGENTS CHIMIQUES ET AUX MOISSISSURES
- UNANGREIFBAR DURCH CHEMISCHE STOFFE UND SCHIMMEL
- RESISTENTE A LOS AGENTES QUÍMICOS Y A LOS MOHOS

Applicazioni - Applications - Applications - Verlegung - Aplicaciones

- Posa diretta su erba
- Direct installation on grass
- Pose direct sur de l'herbe
- Verlegung direkt auf Rasen
- Colocación directa sobre hierba

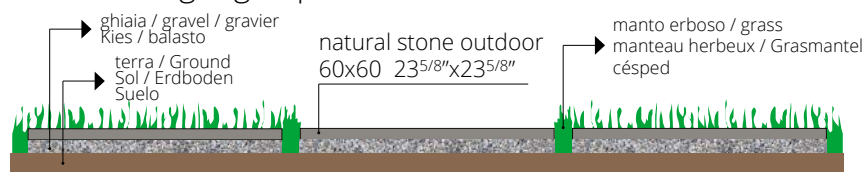

- Posa diretta su ghiaia
- Direct installation over gravel
- Pose direct sur du gravier
- Verlegung direkt auf Kies
- Colocación directa sobre grava



- Posa su massetto cementizio
- Installation on sand-cement screed
- Pose sur chape ciment
- Verlegung auf Zement-Unterbetonblock
- Colocación sobre contrapiso de hormigón

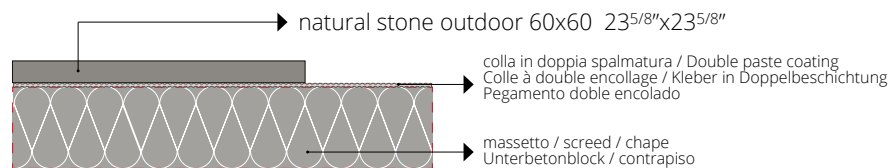

- Posa su piedini fissi o regolabili
- Installation on fixed or adjustable feet
- Pose sur pieds fixes ou réglables
- Verlegung auf feststehende oder regulierbare Füße
- Colocación sobre pies fijos o regulables

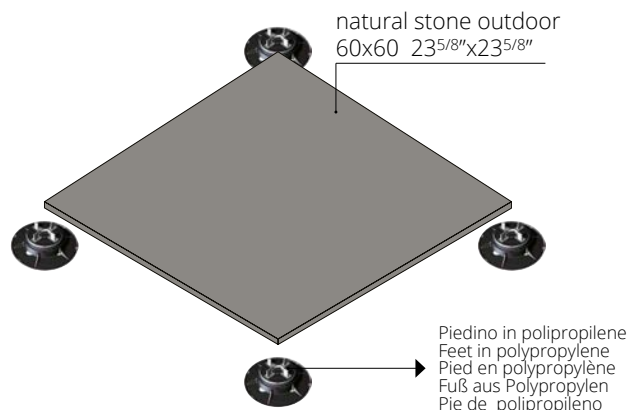

Per le specifiche di utilizzo dei sistemi sopraelevati vedi il sito florim.com
For the specifics on use of raised systems visit the site florim.com
Pour les caractéristiques d'utilisation des systèmes surélevés, voir le site florim.com
Für die Nutzungsbedingungen der Doppelbodensysteme siehe Webseite florim.com
Para las especificaciones de empleo de los sistemas sobreelevados consulte el sitio web florim.com

Le lastre ceramiche sono sottoposte a un trattamento di compattazione termica che assicura resistenza e durata nel tempo. Il bassissimo assorbimento d'acqua rende perciò il materiale ingelivo. Ciò può comportare ristagni d'acqua superficiali anche per materiale installato a regola d'arte. / Ceramic tiles undergo a compacting thermal treatment that ensures resistance and durability. The low level of water absorption makes the slabs frost resistant. This could result in superficial water stagnations even if materials are installed in a workmanlike manner. / Les carreaux de céramique subissent un traitement thermique de compactage qui assure résistance et durabilité. Le bas niveau d'absorption d'eau rend les dalles résistant au gel. Il pourrait en résulter des stagnations d'eau superficielles, même si les dalles ont été installées dans les règles de l'art. / Die Keramikplatten werden einer thermischen Verdichtung unterzogen, welche die Widerstandsfähigkeit und Langlebigkeit sichert. Die extrem niedrige Wasseraufnahme macht das Material frostsicher. Die hohe Materialdichte kann, auch bei einer perfekten Verlegung, eine längere Abtrochnungszeit von angestaumtem Wasser zur Folge haben. / Las baldosas cerámicas se someten a un tratamiento de compactación térmica que asegura resistencia y durabilidad. La baja absorción de agua hace que las baldosas resistan al hielo. Esto podría resultar en estancamientos superficiales de agua, incluso si los materiales están instalados según las reglas del arte.

WHITE



CREAM

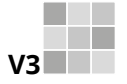

R11

20 mm 3/4" ↑↓

FOSSIL

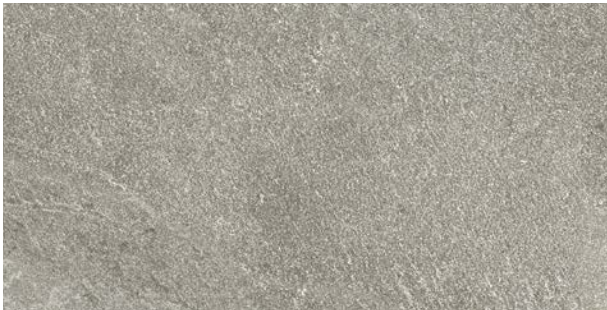

MINERAL





COAL



GRES FINE PORCELLANATO

FINE PORCELAIN STONEWARE/GRES CERAME FIN/FEINSTEINZEUG-KOLLEKTIONEN/GRES PORCELANICO FINO
SQUADRATO - SQUARED - EQUARRI - REKTIFIZIERT - ESCUADRADO

		COLOR	SURFACE	60x60 23 ^{5/8} "x23 ^{5/8} "
		WHITE	BOCCIARDATO	753277 ■ FL-07300
		CREAM	BOCCIARDATO	752150 ■ FL-07300
NATURAL STONE		FOSSIL	BOCCIARDATO	752151 ■ FL-07300
		MINERAL	BOCCIARDATO	753278 ■ FL-07300
		COAL	BOCCIARDATO	753279 ■ FL-07300



Product Certification
BUREAU VERITAS
Certification

Recycled material content certification

ISO 10545-4	RESISTENZA ALLA FLESSIONE IN N/mm ² N/mm ² FLEXURAL STRENGTH TEST / RESISTANCE A LA FLEXION EN N/mm ² / BIEGEFESTIGKEIT IN N/mm ² / RESISTENCIA A LA FLEXION EN N/mm ²	valore medio 52 N/mm ²
	Forza di rottura in N (sp. > 7,5 mm) Breaking strength in N (thickness > 7,5 mm) / Force de rupture en N (ep. > 7,5 mm) / Bruchlast in N (Dicke > 7,5 mm) / Fuerza de rotura en N (gc. > 7,5 mm)	valore medio 14000 N

PEZZI SPECIALI

Special trims/Pièces spéciales/Formstücke
Piezas especiales
pag 150/151

NATURAL STONE	scatola - box			pallet		
	pz	mq	kg	box	mq	kg
60x60 20mm	2	0,72	32,15	30	21,60	990



ONYX

gres porcellanato smaltato
glazed porcelain stoneware
gres cérame émaillé
glasierte Feinsteinzeug
gres Porcelánico esmaltado





ONYX

Esuberante e voluttuosa questa materia antica arricchisce di sfumature preziose la proposta estetica di Contemporary design. La luce accarezza le superfici luminose facendo risplendere i dettagli più nascosti in cui perdersi immaginando luoghi lontani e atmosfere delicate. Nel segno del tempo e della tradizione arriva un nuovo spirito elegante ma capace di modernità.

Exuberant and voluptuous, this ancient material uses precious shades to enrich Contemporary design aesthetic proposal. Light caresses the bright surfaces, making the most hidden details resplendent, a moment to lose oneself imagining faraway places and subtle atmospheres. The arrival of a new spirit - in the name of time and tradition - which is stylish, yet capable of modern appeal.

Exubérante et voluptueuse, cette matière ancienne enrichit de précieuses nuances la proposition esthétique de Contemporary design. La lumière caresse les surfaces lumineuses, en faisant briller les détails les plus cachés dans lesquels se perdre en imaginant des lieux lointains et des atmosphères délicates. Sous le signe du temps et de la tradition, un nouvel esprit élégant, mais capable de modernité, s'invite.

Dieses klassische Material bereichert das Gestaltungsangebot von Contemporary design dank seiner Üppigkeit und Sinnlichkeit um edle Nuancierungen. Das Licht umschmeichelt die strahlenden Oberflächen und bringt verborgene Details zum Glänzen, in denen man sich verlieren, an ferne Orte denken und sanfte Atmosphären ersinnen kann. Im Zeichen der Zeit und der Tradition entsteht ein neuartiger, eleganter Esprit, der Modernität verspricht.

Exuberante y voluptuosa, esta antigua materia enriquece con sus preciosos matices la propuesta estética de Contemporary design. La luz acaricia las superficies luminosas, haciendo resplandecer recónditos detalles en los cuales perdernos, imaginando lugares remotos y delicadas atmósferas. Bajo el signo del tiempo y la tradición, llega un nuevo espíritu que combina elegancia y modernidad.

ONYX OF CERIM

WHITE





SAND



9 mm 3/8" ↑↓

GRES PORCELLANATO SMALTATO

GLAZED PORCELAIN STONEWARE / GRES CÉRAMÉ ÉMAILLÉ / GLASIERTE FEINSTEINZEUG / GRES PORCELÁNICO ESMALTADO
SQUADRATO - SQUARED - EQUARRI - REKTIFIZIERT - ESCUADRADO



9 mm 3/8" ↑↓		COLOR	SURFACE	60x120 23 ^{5/8"} x47 ^{1/4"}	30x60 11 ^{4/5"} x23 ^{5/8"}
ONYX		WHITE	LUCIDO	752920 ■ FL-09300	752922 ■ FL-05800
			NATURALE	754392 ■ FL-07700	753699 ■ FL-04600
		SAND	LUCIDO	752522 ■ FL-09300	752530 ■ FL-05800
			NATURALE	754391 ■ FL-07700	753700 ■ FL-04600

CLOUD

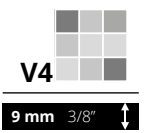





SHADOW



GRES PORCELLANATO SMALTATO
 GLAZED PORCELAIN STONEWARE / GRES CÉRAMÉ ÉMAILLÉ / GLASIERTE FEINSTEINZEUG / GRES PORCELÁNICO ESMALTADO
 SQUADRATO - SQUARED - EQUARRI - REKTIFIZIERT - ESCUADRADO

9 mm 3/8" ↑↓		COLOR	SURFACE	60x120 23 ^{5/8"} x47 ^{1/4"}	30x60 11 ^{4/5"} x23 ^{5/8"}
ONYX		CLOUD	LUCIDO	752523 ■ FL-09300	752531 ■ FL-05800
			NATURALE	754389 ■ FL-07700	753701 ■ FL-04600
		SHADOW	LUCIDO	752519 ■ FL-09300	752532 ■ FL-05800
			NATURALE	754390 ■ FL-07700	753706 ■ FL-04600



ONYX

9 mm 3/8" 	COLOR	SURFACE	30x30 11 4/5" x 11 4/5"  mosaico tessere 3x3 pz/box 11	0,5x60 1/4" x 23 5/8" <hr/> matita inox pz/box 4	
ONYX		WHITE	LUCIDO	752925 ▲ FL-01800	<hr/> 719674 ▲ FL-03100
			NATURALE	754513 ▲ FL-01600	
		SAND	LUCIDO	752537 ▲ FL-01800	
			NATURALE	754509 ▲ FL-01600	
		CLOUD	LUCIDO	752540 ▲ FL-01800	
			NATURALE	754512 ▲ FL-01600	
		SHADOW	LUCIDO	752538 ▲ FL-01800	
			NATURALE	754510 ▲ FL-01600	



Per un effetto ottimale della posa, florim suggerisce di mantenere 2 mm di fuga per pose monoformato e 3 mm per combinare formati misti - For optimal installation results, florim recommends maintaining a joint of 2 mm 1/12" for single format installations and 3 mm 1/8" to combine mixed formats. - Pour réaliser une pose parfaite, florim suggère de maintenir 2 mm de joint pour la pose des monoformats, et 3 mm pour les combinaisons de formats mixtes. - Um einen optimalen effekt beim verlegen zu erzielen empfiehlt florim eine 2 mm fugе bei einformatigen verlegungen und 3 mm fugе bei formatkombinationen Para lograr los máximos resultados en la posa del producto, florim aconseja 2 mm de junta en aplicaciones monoformato y 3 mm en combinaciones de formatos mixtos.

PEZZI SPECIALI/SPECIAL TRIMS/PIÈCES SPÉCIALES/FORMSTÜCKE/PIEZAS ESPECIALES

9 mm 3/8" 		COLOR	SURFACE	4,6x60 1 4/5" x 2 3/8"  battiscopa
ONYX		WHITE	LUCIDO	752926 ◆ FL-01600
			NATURALE	753751 ◆ FL-01600
		SAND	LUCIDO	752542 ◆ FL-01600
			NATURALE	753752 ◆ FL-01600
		CLOUD	LUCIDO	752543 ◆ FL-01600
			NATURALE	753753 ◆ FL-01600
		SHADOW	LUCIDO	752545 ◆ FL-01600
			NATURALE	753755 ◆ FL-01600

ONYX	scatola - box			pallet		
	pz	mq	kg	box	mq	kg
60x120	2	1,44	28,08	30	43,20	870
30x60	6	1,08	20,84	40	43,20	860

ONYX	scatola - box			pallet		
	pz	ml	kg	box	mq	kg
4,6x60 battiscopa	14	8,40	8,40	-	-	-



ROCK SALT

gres porcellanato smaltato
glazed porcelain stoneware
gres cérame émaillé
glasierte Feinsteinzeug
gres Porcelánico esmaltado





ROCK SALT

La collezione **Rock Salt** reinterpreta il sapore dei grandi blocchi di salgemma estratti nelle miniere del sottosuolo e utilizzati anche per la realizzazione di pareti e cristalli di sale, la sua suggestiva naturalità è capace di rendere contemporanei gli spazi abitativi. Con Rock Salt è possibile creare spazi confortevoli in cui trovare pace dalla frenesia dei ritmi quotidiani, per vivere la casa come spazio semplice e privato.

The **Rock Salt** collection reinterprets the flavour of large blocks of rock salt extracted from underground mines and also utilized in the making of walls and salt crystals, its evocative naturalness can give living spaces a contemporary feel. Rock Salt is perfectly suited to creating comfortable spaces where you can find repose from the frenzy of daily life, and experience your home as a simple, private space.

La collection **Rock Salt** réinterprète la saveur des grands blocs de sel gemme extraits des mines souterraines et utilisés également pour la réalisation de murs et de cristaux de sel, son caractère naturel suggestif sait moderniser les espaces de vie. Rock Salt permet de créer des espaces confortables où se retirer de la frénésie des rythmes quotidiens, pour vivre la maison comme un espace simple et privé.

Die Kollektion **Rock Salt** interpretiert den Flair der großen Steinsalzblöcke, die im Untertagebau gefördert und auch für die Anfertigung von Wänden und Salzkristallen verwendet werden, komplett neu. Dank ihrer atemberaubenden Natürlichkeit werden Wohnräume dem zeitgenössischen Geschmack gerecht. Mit Rock Salt sind komfortable Räume möglich, in denen man Ruhe vor der Alltagshektik findet um das Zuhause mühelos einfach und ganz privat erleben kann.

La colección **Rock Salt** reinterpreta el sabor de los grandes bloques de halita extraídos de las minas del subsuelo y utilizados también para la realización de paredes y cristales de sal. Su sugestiva naturalidad es capaz de convertir las viviendas en lugares contemporáneos. Con Rock Salt se pueden crear espacios confortables donde poder encontrar la paz, alejados de los frenéticos ritmos cotidianos, para vivir la casa como un espacio sencillo y privado.

ROCK SALT

WHITE GOLD



CELTIC GREY

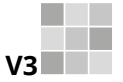

R10
CLASSE B
(naturale)

R11
CLASSE B
(bocciardato)

DCOF>
0,42 Wet
(naturale/
bocciardato)

9 mm 3/8" ↑↓

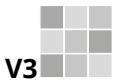

R10
CLASSE B
(naturale)



DCOF>
0,42 Wet
(naturale)



6 mm 1/4" ↑↓

FLOORM OVERSIZE
magnUlm

GRES PORCELLANATO SMALTATO

GLAZED PORCELAIN STONEWARE / GRES CÉRAMÉ ÉMAILLÉ / GLASIERTE FEINSTEINZEUG / GRES PORCELÁNICO ESMALTADO
SQUADRATO - SQUARED - EQUARRI - REKTIFIZIERT - ESCUADRADO

9 mm 3/8" ↑↓		COLOR	SURFACE	60x120 23 ^{5/8"} x47 ^{1/4"}	60x60 23 ^{5/8"} x23 ^{5/8"}	30x60 11 ^{4/5"} x23 ^{5/8"}
ROCK SALT		WHITE GOLD	LUCIDO	765855 ■ FL-09300	765891 ■ FL-07300	765914 ■ FL-05800
			NATURALE	765849 ■ FL-07700	765883 ■ FL-05800	765905 ■ FL-04600
			BOCCIARDATO	-	-	767930 ■ FL-04600
		CELTIC GREY	LUCIDO	765856 ■ FL-09300	765895 ■ FL-07300	765916 ■ FL-05800
			NATURALE	765850 ■ FL-07700	765884 ■ FL-05800	765909 ■ FL-04600
			BOCCIARDATO	-	-	767932 ■ FL-04600

6 mm 1/4" ↑↓		COLOR	SURFACE	120x240 47 ^{1/4"} x94 ^{1/2"}	120x120 47 ^{1/4"} x47 ^{1/4"}	60x120 23 ^{5/8"} x47 ^{1/4"}
ROCK SALT		WHITE GOLD	LUCIDO	766912 ■ FL-11300	766923 ■ FL-09300	766934 ■ FL-08600
			NATURALE	766907 ■ FL-08400	766917 ■ FL-07000	766929 ■ FL-06700
			LUCIDO	766913 ■ FL-11300	766924 ■ FL-09300	766935 ■ FL-08600
		CELTIC GREY	NATURALE	766908 ■ FL-08400	766919 ■ FL-07000	766930 ■ FL-06700

DANISH SMOKE



MAUI GREEN

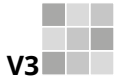

V3
R10
CLASSE B
 (naturale)

R11
CLASSE B
 (bocciardato)

DCOF>
 0,42 Wet
 (naturale/
 bocciardato)

9 mm 3/8" ↑↓



V3
R10
CLASSE B
 (naturale)

DCOF>
 0,42 Wet
 (naturale)

6 mm 1/4" ↑↓

FLORM OVERSIZE
magnUm

GRES PORCELLANATO SMALTATO

GLAZED PORCELAIN STONEWARE / GRES CÉRAMÉ ÉMAILLÉ / GLASIERTE FEINSTEINZEUG / GRES PORCELÁNICO ESMALTADO
 SQUADRATO - SQUARED - EQUARRI - REKTIFIZIERT - ESCUADRADO

9 mm 3/8" ↑↓		COLOR	SURFACE	60x120 23 ^{5/8"} x47 ^{1/4"}	60x60 23 ^{5/8"} x23 ^{5/8"}	30x60 11 ^{4/5"} x23 ^{5/8"}
ROCK SALT	DANISH SMOKE	LUCIDO		765857 ■ FL-09300	765896 ■ FL-07300	765917 ■ FL-05800
		NATURALE		765851 ■ FL-07700	765885 ■ FL-05800	765910 ■ FL-04600
		BOCCIARDATO		-	-	767933 ■ FL-04600
	MAUI GREEN	LUCIDO		765858 ■ FL-09300	765897 ■ FL-07300	765918 ■ FL-05800
		NATURALE		765852 ■ FL-07700	765887 ■ FL-05800	765911 ■ FL-04600
		BOCCIARDATO		-	-	767934 ■ FL-04600

6 mm 1/4" ↑↓		COLOR	SURFACE	120x240 47 ^{1/4"} x94 ^{1/2"}	120x120 47 ^{1/4"} x47 ^{1/4"}	60x120 23 ^{5/8"} x47 ^{1/4"}
ROCK SALT	DANISH SMOKE	LUCIDO		766914 ■ FL-11300	766925 ■ FL-09300	766936 ■ FL-08600
		NATURALE		766909 ■ FL-08400	766920 ■ FL-07000	766931 ■ FL-06700
		LUCIDO		766915 ■ FL-11300	766927 ■ FL-09300	766937 ■ FL-08600
	MAUI GREEN	NATURALE		766910 ■ FL-08400	766921 ■ FL-07000	766932 ■ FL-06700

ROCK SALT

HAWAIIAN RED

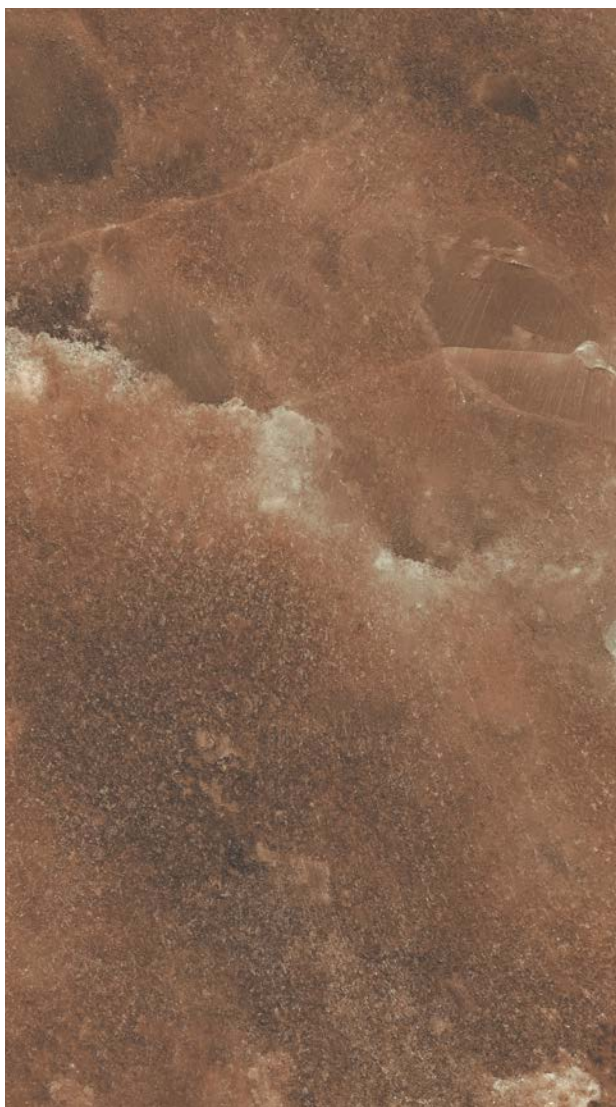

V3
R10
CLASSE B
 (naturale)

R11
CLASSE B
 (bocciardato)

DCOF >
 0,42 Wet
 (naturale/
 bocciardato)

9 mm 3/8" ↑↓









GRES PORCELLANATO SMALTATO

GLAZED PORCELAIN STONEWARE / GRES CÉRAMÉ ÉMAILLÉ / GLASIERTE FEINSTEINZEUG / GRES PORCELÁNICO ESMALTADO
 SQUADRATO - SQUARED - EQUARRI - REKTIFIZIERT - ESCUADRADO

9 mm 3/8" ↑↓	COLOR	SURFACE	60x120	60x60	30x60
			23 ^{5/8"} x47 ^{1/4"}	23 ^{5/8"} x23 ^{5/8"}	11 ^{4/5"} x23 ^{5/8"}
ROCK SALT	 HAWAIIAN RED	LUCIDO	765859 ■ FL-09300	765898 ■ FL-07300	765919 ■ FL-05800
		NATURALE	765853 ■ FL-07700	765889 ■ FL-05800	765912 ■ FL-04600
		BOCCIARDATO	-	-	767935 ■ FL-04600



ROCK SALT

9 mm 3/8" ↑				30x30 11 4/5" x 11 4/5"  mosaico tessere 3x3 pz/box 11	30x30 11 4/5" x 11 4/5"  mosaico 3D tessere 5x30 pz/box 8	15x60 6" x 23 5/8"  modulo listello sfalsato mix naturale/lucido pz/box 6
		COLOR	SURFACE			
ROCK SALT		WHITE GOLD	LUCIDO	766711 ▲ FL-01800	766713 ▲ FL-03800	766710 ▲ FL-03600
			NATURALE	766714 ▲ FL-01600	766716 ▲ FL-03600	
		CELTIC GREY	LUCIDO	766715 ▲ FL-01800	766728 ▲ FL-03800	766752 ▲ FL-03600
			NATURALE	766717 ▲ FL-01600	766727 ▲ FL-03600	
		DANISH SMOKE	LUCIDO	766730 ▲ FL-01800	766732 ▲ FL-03800	766753 ▲ FL-03600
			NATURALE	766729 ▲ FL-01600	766731 ▲ FL-03600	
		MAUI GREEN	LUCIDO	766734 ▲ FL-01800	766736 ▲ FL-03800	766754 ▲ FL-03600
			NATURALE	766733 ▲ FL-01600	766735 ▲ FL-03600	
		HAWAIIAN RED	LUCIDO	766738 ▲ FL-01800	766741 ▲ FL-03800	766755 ▲ FL-03600
			NATURALE	766737 ▲ FL-01600	766740 ▲ FL-03600	

PEZZI SPECIALI/SPECIAL TRIMS/PIÈCES SPÉCIALES/FORMSTÜCKE/PIEZAS ESPECIALES

9 mm 3/8" ↑				4,6x60 1 4/5" x 23 5/8"  battiscopa
		COLOR	SURFACE	
ROCK SALT		WHITE GOLD	LUCIDO	766719 ◆ FL-01600
			NATURALE	766718 ◆ FL-01600
		CELTIC GREY	LUCIDO	766739 ◆ FL-01600
			NATURALE	766720 ◆ FL-01600
		DANISH SMOKE	LUCIDO	766742 ◆ FL-01600
			NATURALE	766721 ◆ FL-01600
		MAUI GREEN	LUCIDO	766744 ◆ FL-01600
			NATURALE	766722 ◆ FL-01600
		HAWAIIAN RED	LUCIDO	766745 ◆ FL-01600
			NATURALE	766723 ◆ FL-01600

9 mm 3/8" ↑

Product Certification
BUREAU VERITAS
 Certification

Recycled material content certification



Contemporary design

6 mm 1/4" ↑↓

PEZZI SPECIALI/SPECIAL TRIMS/
PIÈCES SPÉCIALES/FORMSTÜCKE/
PIEZAS ESPECIALES

	COLOR	SURFACE	30x30 11 ^{4/5"} x11 ^{4/5"} mosaico tessere 7,5x7,5 pz/box 11	30x30 11 ^{4/5"} x11 ^{4/5"} muretto tessere 7,5x15 pz/box 11	4,6x60 1 ^{4/5"} x23 ^{5/8"} battiscopa
ROCK SALT	WHITE GOLD	LUCIDO	766771 ▲ FL-02100	766760 ▲ FL-02100	766786 ◆ FL-01800
		NATURALE	766768 ▲ FL-01800	766757 ▲ FL-01800	766777 ◆ FL-01800
	CELTIC GREY	LUCIDO	766774 ▲ FL-02100	766761 ▲ FL-02100	766787 ◆ FL-01800
		NATURALE	766773 ▲ FL-01800	766758 ▲ FL-01800	766781 ◆ FL-01800
	DANISH SMOKE	LUCIDO	766776 ▲ FL-02100	766765 ▲ FL-02100	766788 ◆ FL-01800
		NATURALE	766775 ▲ FL-01800	766764 ▲ FL-01800	766783 ◆ FL-01800
	MAUI GREEN	LUCIDO	766779 ▲ FL-02100	766769 ▲ FL-02100	766789 ◆ FL-01800
		NATURALE	766778 ▲ FL-01800	766767 ▲ FL-01800	766784 ◆ FL-01800

FLORM OVERSIZE
magnUm

120x240/120x120/60x120

Specifica Imballo pag.
Packaging specifications on page
Spécifications d'emballage à page
Verpackungsdetail Seite
Especificaciones de embalaje a la página
158/159

Per un effetto ottimale della posa, florm suggerisce di mantenere 2 mm di fuga per pose monofornate e 3 mm per combinare formati misti. - For optimal installation results, florm recommends maintaining a joint of 2 mm 1/16" for single format installations and 3 mm 1/8" to combine mixed formats. - Pour réaliser une pose parfaite, florm suggère de maintenir 2 mm de joint pour la pose des monofornats, et 3 mm pour les combinaisons de formats mixtes. - Um einen optimalen effekt beim verlegen zu erzielen empfiehlt florm eine 2 mm fugе bei einformatigen verlegungen und 3 mm fugе bei formatkombinationen Para lograr los máximos resultados en la posa del producto, florm aconseja 2 mm de junta en aplicaciones monofornate y 3 mm en combinaciones de formatos mixtos.

3D: Si consiglia la posa con stucco epossidico per ambienti bagnati o sottoposti a forte umidità. / 3D: We recommend laying with epoxy putty for wet environments or those subject to strong humidity. / 3D:pose conseillée avec mortier époxy pour environnements très humides ou mouillés. / 3D: In nassen oder starker Feuchtigkeit ausgesetzten Bereichen empfiehlt sich die Verlegung mit Epoxidstuck. / 3D: En ambientes mojados o muy húmedos, se recomienda realizar la colocación con estuco epoxidico.

In relazione alle differenti tecnologie produttive l'accostamento di prodotti con spessori diversi potrebbe presentare delle disomogeneità, se ne sconsiglia pertanto l'abbinamento. Due to the different production technologies, contiguous installation of products with different thickness may give a non-homogeneous result. For this reason we do not recommend this option. / Vu que différentes technologies de production sont utilisées avec des épaisseurs différentes, des problèmes d'homogénéité pourraient se présenter, il est donc déconseillé de les poser ensemble. / Wegen unterschiedlicher Produktionstechnologien können die Fliesen mit verschiedenen Materialstärken optische Differenzen aufweisen. Von einem direkten Aneinanderlegen wird deshalb abgeraten. / Dadas las diferentes tecnologías productivas, la combinación de productos de diferentes espesores podría dar lugar a heterogeneidad, por lo que se desaconseja mezclarlas.

ROCK SALT	scatola - box			pallet		
	pz	mq	kg	box	mq	kg
60x120	2	1,44	28,08	30	43,20	870
60x60	3	1,08	21,06	40	43,20	870
30x60	6	1,08	20,84	40	43,20	860

ROCK SALT	scatola - box			pallet		
	pz	ml	kg	box	mq	kg
4,6x60 battiscopa	14	8,40	8,40	-	-	-

ROCK SALT OUTDOOR

Vantaggi tecnici - Technical advantages - Avantages techniques Technische Vorteile - Ventajas técnicas

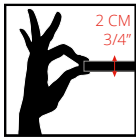

- Lastra monolitica compatta di spessore 2 cm squadrata e rettificata
- Compact monolithic slab 2 cm thick squared and rectified
- Dalle monolithique compacte de 2 cm d'épaisseur, égarrie et rectifiée
- Kompakte monolithische Platte, 2 cm dick, rechteckig und scharfkantig geschliffen
- Losa monolítica compacta de 2 cm de espesor, esquadrada y rectificada.

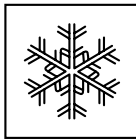

- INGELIVO
- FROST RESISTANT
- INGÉLIF
- FROSTBESTÄNDIG
- RESISTENTE A LA HELADA

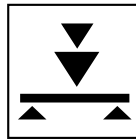

- ELEVATA RESISTENZA AI CARICHI STATICI
- HIGH STATIC LOAD RESISTANCE
- RÉSISTANCE ÉLEVÉE AUX CHARGES STATIQUES
- HOHE STATISCHE BELASTBARKEIT
- ELEVADA RESISTENCIA A LAS CARGAS ESTÁTICAS

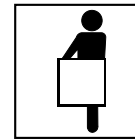

- FACILE DA POSARE
- EASY TO INSTALL
- FACILE À POSER
- VERLEGELEICHT
- FÁCIL DE COLOCAR



- ANTISCIVOLO R11
- ANTI SLIP R11
- ANTIDÉRAPANT R11
- RUTSCHFEST R11
- ANTIDESLIZANTE R11

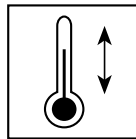

- RESISTENTE AGLI SBALZI TERMICI
- THERMAL SHOCK RESISTANT
- RÉSISTANT AUX ÉCARTS THERMIQUES
- TEMPERATURWECHSELBESTÄNDIG
- RESISTENTE A LAS OSCILACIONES TÉRMICAS



- FACILE DA PULIRE
- EASY TO CLEAN
- FACILE À NETTOYER
- REINIGUNGSLEICHT
- FÁCIL DE LIMPIAR

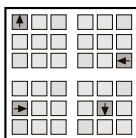

- RIMOVIBILE E RIUTILIZZABILE
- REMOVABLE AND REUSABLE
- DÉMONTABLE ET RÉUTILISABLE
- ENTFERNBAR UND WIEDERVERWENDBAR
- DESMONTABLE Y REUTILIZABLE



- INATTACCABILE DA AGENTI CHIMICI E MUFFE
- IMPERVIOUS TO ATTACK BY CHEMICALS OR MOULD
- RÉSISTANT AUX AGENTS CHIMIQUES ET AUX MOISSISSURES
- UNANGREIFBAR DURCH CHEMISCHE STOFFE UND SCHIMMEL
- RESISTENTE A LOS AGENTES QUÍMICOS Y A LOS MOHOS

Applicazioni - Applications - Applications - Verlegung - Aplicaciones

- Posa diretta su erba
- Direct installation on grass
- Pose direct sur de l'herbe
- Verlegung direkt auf Rasen
- Colocación directa sobre hierba



- Posa diretta su ghiaia
- Direct installation over gravel
- Pose direct sur du gravier
- Verlegung direkt auf Kies
- Colocación directa sobre grava



- Posa su massetto cementizio
- Installation on sand-cement screed
- Pose sur chape ciment
- Verlegung auf Zement-Unterbetonblock
- Colocación sobre contrapiso de hormigón

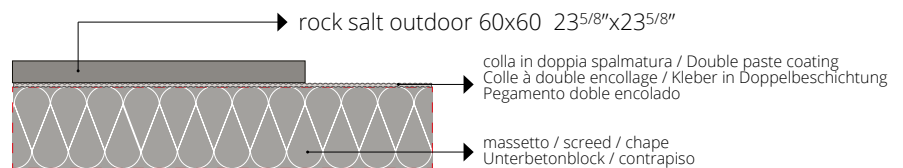

- Posa su piedini fissi o regolabili
- Installation on fixed or adjustable feet
- Pose sur pieds fixes ou réglables
- Verlegung auf feststehende oder regulierbare Füße
- Colocación sobre pies fijos o regulables

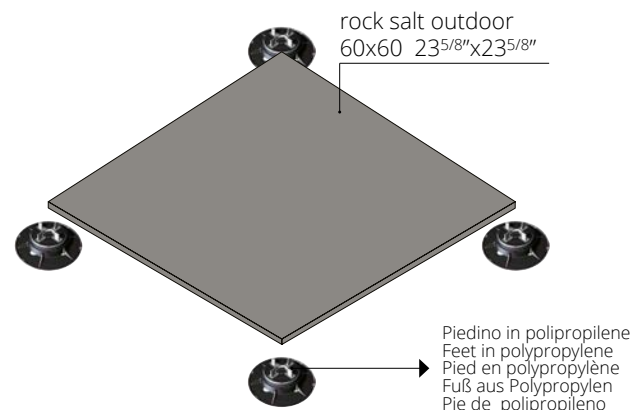

Per le specifiche di utilizzo dei sistemi sopraelevati vedi il sito florim.com
For the specifics on use of raised systems visit the site florim.com
Pour les caractéristiques d'utilisation des systèmes surélevés, voir le site florim.com
Für die Nutzungsbedingungen der Doppelbodensysteme siehe Webseite florim.com
Para las especificaciones de empleo de los sistemas sobreelevados consulte el sitio web florim.com

Le lastre ceramiche sono sottoposte a un trattamento di compattazione termica che assicura resistenza e durata nel tempo. Il bassissimo assorbimento d'acqua rende perciò il materiale ingelivo. Ciò può comportare ristagni d'acqua superficiali anche per materiale installato a regola d'arte. / Ceramic tiles undergo a compacting thermal treatment that ensures resistance and durability. The low level of water absorption makes the slabs frost resistant. This could result in superficial water stagnations even if materials are installed in a workmanlike manner. / Les carreaux de céramique subissent un traitement thermique de compactage qui assure résistance et durabilité. Le bas niveau d'absorption d'eau rend les dalles résistant au gel. Il pourrait en résulter des stagnations d'eau superficielles, même si les dalles ont été installées dans les règles de l'art. / Die Keramikplatten werden einer thermischen Verdichtung unterzogen, welche die Widerstandsfähigkeit und Langlebigkeit sichert. Die extrem niedrige Wasseraufnahme macht das Material frostsicher. Die hohe Materialdichte kann, auch bei einer perfekten Verlegung, eine längere Abtrocknungszeit von angestaumtem Wasser zur Folge haben. / Las baldosas cerámicas se someten a un tratamiento de compactación térmica que asegura resistencia y durabilidad. La baja absorción de agua hace que las baldosas resistan al hielo. Esto podría resultar en estancamientos superficiales de agua, incluso si los materiales están instalados según las reglas del arte.

WHITE GOLD



CELTIC GREY

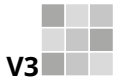

R11
CLASSE B

20 mm 3/4" ↑↓

DANISH SMOKE



GRES FINE PORCELLANATO

FINE PORCELAIN STONEWARE/GRES CERAME FIN/FEINSTEINZEUG-KOLLEKTIONEN/GRES PORCELANICO FINO
SQUADRATO - SQUARED - EQUARRI - REKTIFIZIERT - ESCUADRADO

	COLOR	SURFACE	20 mm 3/4" ↑↓	
			60x120 23 ⁵ / ₈ "x47 ¹ / ₄ "	60x60 23 ⁵ / ₈ "x23 ⁵ / ₈ "
ROCK SALT	 WHITE GOLD	BOCCIARDATO	765928 ■ FL-09100	765934 ■ FL-07300
	 CELTIC GREY	BOCCIARDATO	765932 ■ FL-09100	765937 ■ FL-07300
	 DANISH SMOKE	BOCCIARDATO	768498 ■ FL-09100	768500 ■ FL-07300



PEZZI SPECIALI
Special trims/Pièces spéciales/Formstücke
Piezas especiales
pag 150/151

	RESISTENZA ALLA FLESSIONE IN N/mm² <small>N/mm² FLEXURAL STRENGTH TEST / RESISTANCE A LA FLEXION EN N/mm² / BIEGEFESTIGKEIT IN N/mm² / RESISTENCIA A LA FLEXION EN N/mm²</small>	valore medio 52 N/mm²
	Forza di rottura in N (sp. > 7,5 mm) <small>Breaking strength in N (thickness > 7,5 mm) / Force de rupture en N (ésp. > 7,5 mm) / Bruchlast in N (Dicke > 7,5 mm) / Fuerza de rotura en N (gr. > 7,5 mm)</small>	valore medio 14000 N

ROCK SALT	scatola - box			pallet		
	pz	mq	kg	box	mq	kg
60x120 20mm	1	0,72	32,26	30	21,60	1000
60x60 20mm	2	0,72	32,15	30	21,60	990



TIMELESS

gres porcellanato smaltato
glazed porcelain stoneware
gres cérame émaillé
glasierte Feinsteinzeug
gres Porcelánico esmaltado





TIMELESS

6 materie che superano la prova del tempo; così semplici ed eleganti che appartengono tanto al passato quanto al futuro in una continuità di naturalezza e sinuosa armonia. Sintesi di purezza e modernità **Timeless** riscopre precisi riferimenti estetici e culturali di un passato prestigioso. Nuove potenzialità estetiche si sviluppano attraverso cromatismi, finiture e formati che consentono di personalizzare ogni intervento con soluzioni originali e accattivanti.

6 textures that stand the test of time, so simple and so elegant that they belong not so much to the past as to the future, with a seamless continuity in their natural quality and sinuous harmony. Blending purity with modernity, **Timeless** rediscovers precise aesthetic and cultural references of a prestigious past. New aesthetic potentials are developed through colours, finishes and sizes that allow each furnishing project to be customized with original, appealing solutions.

6 matières intemporelles, si simples et élégantes qu'elles appartiennent tant au passé qu'au futur, dans un continuum naturel d'harmonie sinueuse. Synthèse de pureté et de modernité, **Timeless** renvoie aux références esthétiques et culturelles précises d'un passé prestigieux. De nouvelles possibilités esthétiques se développent à travers des chromatismes, des finitions et des formats qui permettent de personnaliser chaque intervention avec des solutions originales et fascinantes.

6 Materien, die den Test der Zeit bestehen; so einfach und elegant, dass sie in einem Kontinuum der Natürlichkeit und gewundenen Harmonie der Vergangenheit als auch der Zukunft angehören. **Timeless** ist eine Synthese der Reinheit und Modernität und entdeckt präzise ästhetische und kulturelle Bezugswerte einer prestigevollen Vergangenheit wieder. Neue ästhetische Potenziale kommen durch Farbeffekte, Ausführungen und Formate zum Ausdruck, mit denen jeder Eingriff mit originellen, attraktiven Lösungen kundenspezifisch gestaltet werden kann.

6 materias que superan la prueba del tiempo, tan sencillas y elegantes que pertenecen tanto al pasado como al futuro, en una continuidad de naturalidad y armonía sinuosa. Síntesis de pureza y modernidad, **Timeless** redescubre las precisas referencias estéticas y culturales de un prestigioso pasado. Las nuevas posibilidades estéticas se desarrollan a través de cromatismos, acabados y formatos que permiten personalizar cada intervención con soluciones originales y seductoras.

TIMELESS

TIMELESS CALACATTA



TIMELESS AMANI GREY

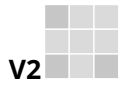

V2

R9
(naturale)

R11
CLASSE B
(grip)

DCOF >
0,42 Wet
(naturale)

9 mm 3/8" ↑↓

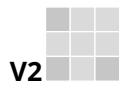

V2

R9
(naturale)

DCOF >
0,42 Wet
(naturale)

6 mm 1/4" ↑↓

FLORM OVERSIZE
magnUm

GRES PORCELLANATO SMALTATO

GLAZED PORCELAIN STONEWARE / GRES CÉRAME ÉMAILLÉ / GLASIERTE FEINSTEINZEUG / GRES PORCELÁNICO ESMALTADO
SQUADRATO - SQUARED - EQUARRI - REKTIFIZIERT - ESCUADRADO

9 mm 3/8" ↑↓	COLOR	SURFACE	60x120	80x80	60x60	30x60
			23 ^{5/8"} x47 ^{1/4"}	31 ^{1/2"} x31 ^{1/2"}	23 ^{5/8"} x23 ^{5/8"}	11 ^{4/5"} x23 ^{5/8"}
TIMELESS	TIMELESS CALACATTA	LUCIDO	744884 ■ FL-08100	753982 ■ FL-08100	746855 ■ FL-06500	746808 ■ FL-05500
		NATURALE	746376 ■ FL-06700	753974 ■ FL-06400	746853 ■ FL-05100	746806 ■ FL-04400
		GRIP	-	-	-	746807 ■ FL-04400
	TIMELESS AMANI GREY	LUCIDO	746377 ■ FL-08100	753975 ■ FL-08100	744872 ■ FL-06500	744856 ■ FL-05500
		NATURALE	744878 ■ FL-06700	753967 ■ FL-06400	744866 ■ FL-05100	744849 ■ FL-04400
		GRIP	-	-	-	744855 ■ FL-04400

6 mm 1/4" ↑↓	COLOR	SURFACE	80x240	80x80
			31 ^{1/2"} x94 ^{1/2"}	31 ^{1/2"} x31 ^{1/2"}
TIMELESS	TIMELESS CALACATTA	LUCIDO	746851 ■ FL-11300	746835 ■ FL-09100
		NATURALE	746843 ■ FL-08400	746827 ■ FL-06500
	TIMELESS AMANI GREY	LUCIDO	746844 ■ FL-11300	746828 ■ FL-09100
		NATURALE	746836 ■ FL-08400	746820 ■ FL-06500

TIMELESS CEPPPO DI GRÈ

TIMELESS BLACK DEEP



V2
CEPPO DI GRÈ

V3
BLACK DEEP

R9
(naturale)

R11
CLASSE B
(grip)

DCOF >
0,42 Wet
(naturale)

9 mm 3/8" ↑↓

V2

R9
(naturale)

DCOF >
0,42 Wet
(naturale)

6 mm 1/4" ↑↓

FLOHM OVERSIZE
magnUm

GRES PORCELLANATO SMALTATO

GLAZED PORCELAIN STONEWARE / GRES CÉRAMÉ ÉMAILLÉ / GLASIERTE FEINSTEINZEUG / GRES PORCELÁNICO ESMALTADO
SQUADRATO - SQUARED - EQUARRI - REKTIFIZIERT - ESCUADRADO

9 mm 3/8" ↑↓	COLOR	SURFACE	60x120 23 ^{5/8"} x47 ^{1/4"}	80x80 31 ^{1/2"} x31 ^{1/2"}	60x60 23 ^{5/8"} x23 ^{5/8"}	30x60 11 ^{4/5"} x23 ^{5/8"}	
	TIMELESS CEPPPO DI GRÈ	LUCIDO	744887 ■ FL-08100	753978 ■ FL-08100	744875 ■ FL-06500	744865 ■ FL-05500	
		NATURALE	744881 ■ FL-06700	753970 ■ FL-06400	744869 ■ FL-05100	744863 ■ FL-04400	
		GRIP	-	-	-	744864 ■ FL-04400	
	TIMELESS	TIMELESS BLACK DEEP	LUCIDO	744889 ■ FL-08100	753977 ■ FL-08100	744874 ■ FL-06500	744862 ■ FL-05500
			NATURALE	744883 ■ FL-06700	753969 ■ FL-06400	744868 ■ FL-05100	744860 ■ FL-04400
			GRIP	-	-	-	744861 ■ FL-04400

6 mm 1/4" ↑↓	COLOR	SURFACE	80x240 31 ^{1/2"} x94 ^{1/2"}	80x80 31 ^{1/2"} x31 ^{1/2"}
TIMELESS	TIMELESS CEPPPO DI GRÈ	LUCIDO	746847 ■ FL-11300	746831 ■ FL-09100
		NATURALE	746839 ■ FL-08400	746823 ■ FL-06500

TIMELESS

TIMELESS TRAVERTINO



TIMELESS MARFIL

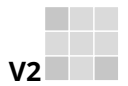

V2

R9
(naturale)

R11
CLASSE B
(grip)

DCOF>
0,42 Wet
(naturale)

9 mm 3/8" ↑↓

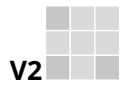

V2

R9
(naturale)



DCOF>
0,42 Wet
(naturale)

6 mm 1/4" ↑↓

FLOORM OVERSIZE
magnUlm







GRES PORCELLANATO SMALTATO

GLAZED PORCELAIN STONEWARE / GRES CÉRAME ÉMAILLÉ / GLASIERTE FEINSTEINZEUG / GRES PORCELÁNICO ESMALTADO
SQUADRATO - SQUARED - EQUARRI - REKTIFIZIERT - ESCUADRADO

9 mm 3/8" ↑↓		COLOR	SURFACE	60x120 23 ^{5/8"} x47 ^{1/4"}	80x80 31 ^{1/2"} x31 ^{1/2"}	60x60 23 ^{5/8"} x23 ^{5/8"}	30x60 11 ^{4/5"} x23 ^{5/8"}
TIMELESS		TIMELESS TRAVERTINO	LUCIDO	744885 ■ FL-08100	753980 ■ FL-08100	744877 ■ FL-06500	746799 ■ FL-05500
			NATURALE	744882 ■ FL-06700	753972 ■ FL-06400	744871 ■ FL-05100	746797 ■ FL-04400
			GRIP	-	-	-	746798 ■ FL-04400
		TIMELESS MARFIL	LUCIDO	744879 ■ FL-08100	753981 ■ FL-08100	746854 ■ FL-06500	746805 ■ FL-05500
			NATURALE	744886 ■ FL-06700	753973 ■ FL-06400	746852 ■ FL-05100	746802 ■ FL-04400
			GRIP	-	-	-	746803 ■ FL-04400

6 mm 1/4" ↑↓		COLOR	SURFACE	80x240 31 ^{1/2"} x94 ^{1/2"}	80x80 31 ^{1/2"} x31 ^{1/2"}
TIMELESS		TIMELESS TRAVERTINO	LUCIDO	746849 ■ FL-11300	746833 ■ FL-09100
			NATURALE	746841 ■ FL-08400	746825 ■ FL-06500

9 mm 3/8" ↑

COLOR	SURFACE	30x30 11 ^{4/5"} x11 ^{4/5"}	30x30 11 ^{4/5"} x11 ^{4/5"}	21x40 8 ^{1/4"} x15 ^{3/4"}	4,6x60 1 ^{4/5"} x23 ^{5/8"}
		mosaico tessere 3x3 pz/box 11	mosaico 3D tessere 5x30 pz/box 8	modulo listello sfalsato pz/box 5	battiscopa
	LUCIDO	747405 ▲ FL-01800	747371 ▲ FL-02100	747413 ▲ FL-01700	747255 ◆ FL-01600
	NATURALE	747389 ▲ FL-01600	747379 ▲ FL-01900	747390 ▲ FL-01600	747241 ◆ FL-01600
	LUCIDO	747407 ▲ FL-01800	747373 ▲ FL-02100	747415 ▲ FL-01700	747257 ◆ FL-01600
	NATURALE	747392 ▲ FL-01600	747381 ▲ FL-01900	747399 ▲ FL-01600	747243 ◆ FL-01600
	LUCIDO	747408 ▲ FL-01800	747374 ▲ FL-02100	747416 ▲ FL-01700	747258 ◆ FL-01600
	NATURALE	747393 ▲ FL-01600	747382 ▲ FL-01900	747400 ▲ FL-01600	747244 ◆ FL-01600
	LUCIDO	747409 ▲ FL-01800	747375 ▲ FL-02100	747417 ▲ FL-01700	747259 ◆ FL-01600
	NATURALE	747394 ▲ FL-01600	747383 ▲ FL-01900	747401 ▲ FL-01600	747245 ◆ FL-01600
	LUCIDO	747410 ▲ FL-01800	747376 ▲ FL-02100	747418 ▲ FL-01700	747260 ◆ FL-01600
	NATURALE	747395 ▲ FL-01600	747384 ▲ FL-01900	747402 ▲ FL-01600	747246 ◆ FL-01600
	LUCIDO	747411 ▲ FL-01800	747377 ▲ FL-02100	747419 ▲ FL-01700	747261 ◆ FL-01600
	NATURALE	747396 ▲ FL-01600	747385 ▲ FL-01900	747403 ▲ FL-01600	747247 ◆ FL-01600

TIMELESS

PEZZI SPECIALI
SPECIAL TRIMS/PIÈCES SPÉCIALES
FORMSTÜCKE/PIEZAS ESPECIALES

9 mm 3/8" ↑



FLOIRIM OVERSIZE
magnUm

80x240/80x80

Specifica Imballo pag.
Packaging specifications on page
Spécifications d'emballage à page
Verpackungsdetail Seite
Especificaciones de embalaje a la página
158/159

I formati 160x160 e 80x240 posso essere acquistati solo a multipli di 2 lastre. / Sales unit for 160x160 and 80x240 is 2 pcs, so they can only be bought in multiples of 2. / Les formats 160x160 et 80x240 sont vendus par multiples de 2 plaques / Die Formate 160x160 und 80x240 können nur in einer durch 2 teilbaren Anzahl bestellt werden / Las medidas 160x160 y 80x240 solo pueden comprarse en múltiplos de 2 placas

Per un effetto ottimale della posa, florim suggerisce di mantenere 2 mm di fuga per pose monoformato e 3 mm per combinare formati misti. - For optimal installation results, florim recommends maintaining a joint of 2 mm 1/16" for single format installations and 3 mm 1/8" to combine mixed formats. - Pour réaliser une pose parfaite, florim suggère de maintenir 2 mm de joint pour la pose des monoformats, et 3 mm pour les combinaisons de formats mixtes. - Um einen optimalen effekt beim verlegen zu erzielen empfiehlt florim eine 2 mm fuge bei einformatigen verlegungen und 3 mm fuge bei formatkombinationen Para lograr los máximos resultados en la posa del producto, florim aconseja 2 mm de junta en aplicaciones monoformato y 3 mm en combinaciones de formatos mixtos.

3D: Si consiglia la posa con stucco epossidico per ambienti bagnati o sottoposti a forte umidità. / 3D: We recommend laying with epoxy putty for wet environments or those subject to strong humidity. / 3D: pose conseillée avec mortier epoxy pour environnements très humides ou mouillés. / 3D: In nassen oder starker Feuchtigkeit ausgesetzten Bereichen empfiehlt sich die Verlegung mit Epoxidstuck. / 3D: En ambientes mojados o muy húmedos, se recomienda realizar la colocación con estuco epoxidico.

In relazione alle differenti tecnologie produttive l'accostamento di prodotti con spessori diversi potrebbe presentare delle disomogeneità, se ne sconsiglia pertanto l'abbinamento. / Due to the different production technologies, contiguous installation of products with different thickness may give a non-homogeneous result. For this reason we do not recommend this option. / Vu que différentes technologies de production sont utilisées avec des épaisseurs différentes, des problèmes d'homogénéité pourraient se présenter, il est donc déconseillé de les poser ensemble. / Wegen unterschiedlicher Produktionstechnologien können die Fliesen mit verschiedenen Materialstärken optische Differenzen aufweisen. Von einem direkten Aneinanderlegen wird deshalb abgeraten. / Dadas las diferentes tecnologías productivas, la combinación de productos de diferentes espesores podría dar lugar a heterogeneidad, por lo que se desaconseja mezclarlas.

TIMELESS	scatola - box			pallet		
	pz	mq	kg	box	mq	kg
60x120	2	1,44	28,08	30	43,20	870
80x80	2	1,28	25,22	40	51,20	1040
60x60	3	1,08	21,49	40	43,20	890
30x60	6	1,08	20,84	40	43,20	860

TIMELESS	scatola - box			pallet		
	pz	ml	kg	box	mq	kg
4,6x60 battiscopa	14	8,40	8,40	-	-	-



WOODSLATE LIFE

gres fine porcellanato
fine porcelain stoneware
gres cerame fin
feinsteinzeug-kollektionen
gres porcelanico fino





WOODSLATE LIFE

Ardesia e legno di quercia. Tocco rustico e sobrietà più attuale. Look rustico unito ad una sensibilità pulita e moderna. Questi sono i tratti distintivi della collezione **Woodslate Life** del Contemporary design. La collezione gioca con materiali nativi, l'ardesia e il legno di quercia, declinati su una scala colori versatile ed accattivante, tra il grigio e il nocciola, che permette di abbinare con facilità ispirazioni naturali differenti. La semplicità pulita dei listoni in legno può diventare quindi lo sfondo sul quale valorizzare la texture materica delle superfici effetto ardesia oppure trasformarsi in elemento distintivo dello spazio grazie ai decori spinati o alla boiserie con effetto 3D. In qualsiasi contesto vengano utilizzate le superfici della collezione Woodslate Life aggiungeranno un tocco autentico e, allo stesso tempo, attuale a qualsiasi ambiente, senza dimenticare la funzionalità dei prodotti in gres porcellanato Made in Florim.

Slate and oak wood. A rustic touch with a more contemporary sobriety. A rustic look combined with a clean, modern sensibility. These are the hallmarks of the **Woodslate Life** Contemporary design collection. The collection toys with the native materials of slate and oak wood, interpreted on a versatile and appealing color scale, from gray to hazelnut, allowing different natural inspirations to be combined with ease. The clean simplicity of the wooden planks can thus become the backdrop against which the textural touch of the slate-effect surfaces can be enhanced, or else become the distinctive element of the space with herringbone decorations or 3D-effect paneling. In whatever context they are used, the surfaces of the Woodslate Life collection will add an authentic and, at the same time, contemporary undertone to any environment, without disregarding the functionality of Made in Florim porcelain stoneware products.

Ardoise et bois de chêne. Touche rustique et sobriété plus contemporaine. Le style rustique allié à une sensibilité sobre et moderne. Ces traits distinctifs définissent la collection **Woodslate Life** du Contemporary design. La collection joue avec des matériaux locaux, l'ardoise et le bois de chêne, déclinés sur une échelle de couleurs polyvalente et séduisante, entre le gris et le noisette, qui permet d'associer facilement différentes inspirations naturelles. La simplicité épurée des planches en bois peut ainsi devenir la toile de fond sur laquelle la texture des surfaces à l'effet ardoise peut être mise en valeur ou devenir l'élément distinctif de l'espace grâce aux motifs à chevrons ou à la boiserie à l'effet 3D. Peu importe le cadre où les surfaces de la collection Woodslate Life sont utilisées : elles conféreront une touche à la fois authentique et contemporaine à n'importe quel espace, tout en offrant la fonctionnalité des produits en grès cérame Made in Florim.

Schiefer und Eichenholz. Rustikale Akzente und moderne Nüchternheit. Concept Ein rustikales Aussehen kombiniert mit einer klaren, modernen Sensibilität. Dies sind die Markenzeichen der Kollektion **Woodslate Life** in Contemporary Design. Die Kollektion spielt mit urtümlichen Materialien wie Schiefer und Eichenholz in einer vielseitigen und ansprechenden Farbskala zwischen Grau und Haselnuss, sodass sich verschiedene natürliche Inspirationen leicht zusammenstellen lassen. Der schlichte Minimalismus der Holzdielen wird so zum Hintergrund, vor dem die Textur der Oberflächen in Schieferoptik zur Geltung kommt, oder sie werden dank des Fischgrätdekor oder der Täfelung in 3D-Optik zu einem markanten Element im Raum. Die Oberflächen der Kollektion Woodslate Life verleihen jeder Umgebung eine authentische und zugleich zeitgemäße Note, ohne dabei die Funktionalität der Feinsteinzeugprodukte Made in Florim zu vergessen.

Pizarra y madera de roble Toque rústico y sobriedad actual. Aspecto rústico unido a una sensibilidad limpia y moderna. Estos son los rasgos distintivos de la colección **Woodslate Life** de Contemporary design. La colección juega con materiales autóctonos, la pizarra y la madera de roble, declinados en una cautivadora y versátil escala de colores que oscila entre el gris y el avellana permitiendo una fácil combinación de diferentes inspiraciones naturales. La limpia simplicidad de los listones de madera puede convertirse así en un fondo sobre el que destacar el acabado texturizado de las superficies efecto pizarra o transformarse en un elemento distintivo del espacio, gracias a las decoraciones con motivo de espiguilla o a la boiserie de efecto 3D. Independientemente del contexto en el que se utilicen, las superficies de la colección Woodslate Life añaden un toque auténtico y actual a cualquier ambiente, sin olvidar la practicidad de los productos de gres porcelánico Made in Florim.

WOODSLATE LIFE

DUNE



CHAMPAGNE



R10
CLASSE B
(naturele)

R11
CLASSE C
(grip)

DCOF >
0,42 Wet
(naturele/
grip)

9 mm 3/8" ↑↓

GRES FINE PORCELLANATO
FINE PORCELAIN STONEWARE / GRÈS CÉRAME FIN / FEINSTEINZEUG-KOLLEKTIONEN / GRES PORCELÁNICO FINO
SQUADRATO - SQUARED - EQUARRI - REKTIFIZIERT - ESCUADRADO

9 mm 3/8" ↑↓		COLOR	SURFACE	20x120 7 7/8" x 47 1/4"
WOODSLATE LIFE		DUNE	NATURALE/MATTE	776411 ■ FL-07300
			GRIP	776428 ■ FL-07300
		CHAMPAGNE	NATURALE/MATTE	776420 ■ FL-07300
			GRIP	776429 ■ FL-07300

NUTMEG



WOODCHUNK

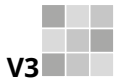



R10
CLASSE B
(naturale)

R11
CLASSE C
(grip)

DCOF>
0,42 Wet
(naturale/
grip)

9 mm 3/8" ↑↓

GRES FINE PORCELLANATO
FINE PORCELAIN STONEWARE / GRÈS CÉRAME FIN / FEINSTEINZEUG-KOLLEKTIONEN / GRES PORCELÁNICO FINO
SQUADRATO - SQUARED - EQUARRI - REKTIFIZIERT - ESCUADRADO

9 mm 3/8" ↑↓		COLOR	SURFACE	20x120 7 ^{11/16"} x47 ^{1/4"}
WOODSLATE LIFE		NUTMEG	NATURALE/MATTE	776421 ■ FL-07300
			GRIP	776430 ■ FL-07300
		WOODCHUNK	NATURALE/MATTE	776422 ■ FL-07300
			GRIP	776431 ■ FL-07300

WOODSLATE LIFE

COTTON



DOVE

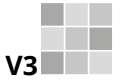

R10
CLASSE B
(naturale)

R11
CLASSE C
(grip)

DCOF >
0,42 Wet
(naturale/
grip)

9 mm 3/8" ↑↓

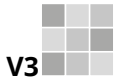

R10
CLASSE B
(naturale)

DCOF >
0,42 Wet
(naturale)

6 mm 1/4" ↑↓

FLOORM OVERSIZE
magnUm

GRES FINE PORCELLANATO

FINE PORCELAIN STONEWARE / GRÈS CÉRAME FIN / FEINSTEINZEUG-KOLLEKTIONEN / GRES PORCELÁNICO FINO
SQUADRATO - SQUARED - EQUARRI - REKTIFIZIERT - ESCUADRADO

				9 mm 3/8" ↑↓		
		COLOR	SURFACE	60x120 23 ^{5/8"} x47 ^{1/4"}	60x60 23 ^{5/8"} x23 ^{5/8"}	30x60 11 ^{4/5"} x23 ^{5/8"}
WOODSLATE LIFE		COTTON	NATURALE/MATTE	776451 ■ FL-07500	776474 ■ FL-05120	776470 ■ FL-05120
			GRIP	776455 ■ FL-07500	-	-
		DOVE	NATURALE/MATTE	776452 ■ FL-07500	776475 ■ FL-05120	776471 ■ FL-05120
			GRIP	776456 ■ FL-07500	-	-

				6 mm 1/4" ↑↓			
		COLOR	SURFACE	120x280 47 ^{1/4"} x110 ^{1/4"}	120x240 47 ^{1/4"} x94 ^{1/2"}	120x120 47 ^{1/4"} x47 ^{1/4"}	60x120 23 ^{5/8"} x47 ^{1/4"}
WOODSLATE LIFE		COTTON	NATURALE/MATTE	776443 ■ FL-09100	776518 ■ FL-08400	776532 ■ FL-07000	776545 ■ FL-06700
		DOVE	NATURALE/MATTE	776444 ■ FL-09100	776521 ■ FL-08400	776534 ■ FL-07000	776546 ■ FL-06700

STORM



BARK

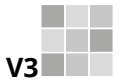

R10
CLASSE B
(naturale)

R11
CLASSE C
(grip)

DCOF>
0,42 Wet
(naturale/
grip)

9 mm 3/8" ↑↓



R10
CLASSE B
(naturale)



DCOF>
0,42 Wet
(naturale)



6 mm 1/4" ↑↓

FLOHM OVERSIZE
magnUm





GRES FINE PORCELLANATO

FINE PORCELAIN STONEWARE / GRÈS CÉRAMÉ FIN / FEINSTEINZEUG-KOLLEKTIONEN / GRES PORCELÁNICO FINO
SQUADRATO - SQUARE - EQUARRI - REKTIFIZIERT - ESCUADRADO

9 mm 3/8" ↑↓		COLOR	SURFACE	60x120 23 ^{5/8"} x47 ^{1/4"}	60x60 23 ^{5/8"} x23 ^{5/8"}	30x60 11 ^{4/5"} x23 ^{5/8"}
WOODSLATE LIFE		STORM	NATURALE/MATTE	776453 ■ FL-07500	776476 ■ FL-05120	776472 ■ FL-05120
			GRIP	776457 ■ FL-07500	-	-
		BARK	NATURALE/MATTE	776454 ■ FL-07500	776477 ■ FL-05120	776473 ■ FL-05120
			GRIP	776458 ■ FL-07500	-	-

6 mm 1/4" ↑↓		COLOR	SURFACE	120x280 47 ^{1/4"} x110 ^{1/4"}	120x240 47 ^{1/4"} x94 ^{1/2"}	120x120 47 ^{1/4"} x47 ^{1/4"}	60x120 23 ^{5/8"} x47 ^{1/4"}
WOODSLATE LIFE		STORM	NATURALE/MATTE	776447 ■ FL-09100	776530 ■ FL-08400	776543 ■ FL-07000	776547 ■ FL-06700
		BARK	NATURALE/MATTE	776445 ■ FL-09100	776531 ■ FL-08400	776544 ■ FL-07000	776548 ■ FL-06700





WOODSLATE LIFE

9 mm 3/8" ↑↓		COLOR	SURFACE	9x60 3 1/2" x 2 3 5/8"	9x60 3 1/2" x 2 3 5/8"
				wood arrow DX	wood arrow SX
WOODSLATE LIFE		DUNE	NATURALE/MATTE	776732 ■ FL-14900	776733 ■ FL-14900
		CHAMPAGNE	NATURALE/MATTE	776734 ■ FL-14900	776735 ■ FL-14900
		NUTMEG	NATURALE/MATTE	776736 ■ FL-14900	776737 ■ FL-14900
		WOODCHUNK	NATURALE/MATTE	776738 ■ FL-14900	776739 ■ FL-14900

9 mm 3/8" ↑↓		COLOR	SURFACE	30x120 11 4/5" x 4 7 1/4"
				wood slats 3D pz/box 3
WOODSLATE LIFE		DUNE	NATURALE/MATTE	776742 ▲ FL-13700
		CHAMPAGNE	NATURALE/MATTE	776743 ▲ FL-13700
		NUTMEG	NATURALE/MATTE	776744 ▲ FL-13700
		WOODCHUNK	NATURALE/MATTE	776745 ▲ FL-13700



PEZZI SPECIALI/SPECIAL TRIMS/PIÈCES SPÉCIALES/FORMSTÜCKE/PIEZAS ESPECIALES

9 mm 3/8" ↑↓		COLOR	SURFACE	4,6x60 1 4/5" x 2 3 5/8"
				battiscopa
WOODSLATE LIFE		DUNE	NATURALE/MATTE	776712 ◆ FL-01600
		CHAMPAGNE	NATURALE/MATTE	776713 ◆ FL-01600
		NUTMEG	NATURALE/MATTE	776714 ◆ FL-01600
		WOODCHUNK	NATURALE/MATTE	776715 ◆ FL-01600

Nelle operazioni di posa a listoni sfalsati, si raccomanda sempre di fare in modo che il lato maggiore della piastrella termini a circa un terzo della lunghezza di quella accanto (posa sfalsata "a 1/3"). - When installing staggered strips, we recommend that the tile's longer side should always end at about one-third of the length of the tiles next to it ("1/3" staggered installation). - Lors de la pose des listels décalés, il faut toujours faire en sorte que le côté le plus grand du carreau se trouve à environ 1/3 de la longueur des carreaux d'à côté (pose décalée "à 1/3"). - Beim Verlegen der Leisten in versetzter Form ist zu beachten, dass die höhere Seite der Fliese immer circa bei einem Drittels der Länge der sich daneben befindlichen Fliesen abschließt ("Um 1/3" versetzte Verlegung). - En las operaciones de colocación de listones escalonados, se recomienda hacerlo siempre de forma tal que el lado mayor del azulejo termine teniendo alrededor de un tercio de la longitud de los contiguos (colocación escalonada "a 1/3").

Per un effetto ottimale della posa, florim suggerisce di mantenere 2 mm di fuga per pose monoformato e 3 mm per combinare formati misti. - For optimal installation results, florim recommends maintaining a joint of 2 mm "1/12" for single format installations and 3 mm "1/8" to combine mixed formats. - Pour réaliser une pose parfaite, florim suggère de maintenir 2 mm de joint pour la pose des monoformats, et 3 mm pour les combinaisons de formats mixtes. - Um einen optimalen Effekt beim Verlegen zu erzielen empfiehlt florim eine 2 mm Fuge bei einformatigen Verlegungen und 3 mm Fuge bei Formatkombinationen. Para lograr los máximos resultados en la posa del producto, florim aconseja 2 mm de junta en aplicaciones monoformato y 3 mm en combinaciones de formatos mixtos.

In relazione alle differenti tecnologie produttive l'accostamento di prodotti con spessori diversi potrebbe presentare delle disomogeneità, se ne sconsiglia pertanto l'abbinamento. / Due to the different production technologies, contiguous installation of products with different thickness may give a non-homogeneous result. For this reason we do not recommend this option. / Vu que différentes technologies de production sont utilisées avec des épaisseurs différentes, des problèmes d'homogénéité pourraient se présenter, il est donc déconseillé de les poser ensemble. / Wegen unterschiedlicher Produktionstechnologien können die Fliesen mit verschiedenen Materialstärken optische Differenzen aufweisen. Von einem direkten Aneinanderlegen wird deshalb abgeraten. / Dadas las diferentes tecnologías productivas, la combinación de productos de diferentes espesores podría dar lugar a heterogeneidad, por lo que se desaconseja mezclarlas.

Contemporary design

9 mm 3/8" ↑↓

	COLOR	SURFACE	<p>slate arrow</p>
--	-------	---------	--------------------

WOODSLATE LIFE



MIX 1
COTTON/DOVE

NATURALE/MATTE

776740
■ FL-11800



MIX 2
STORM/BARK

NATURALE/MATTE

776741
■ FL-11800

9 mm 3/8" ↑↓

	COLOR	SURFACE	<p>30x60 11^{4/5"}x23^{5/8"}</p> <p>muretto sfalsato 3D pz/box 4</p>	<p>4,6x60 1^{4/5"}x23^{5/8"}</p> <p>battiscopa</p>	<p>33x120x3 13"x47^{1/4"}x1^{1/8"}</p> <p>gradino pz/box 2</p>	
WOODSLATE LIFE		COTTON	NATURALE/MATTE	776746 ▲ FL-06000	776716 ◆ FL-01600	776720 ▲ FL-20400
		DOVE	NATURALE/MATTE	776747 ▲ FL-06000	776717 ◆ FL-01600	776721 ▲ FL-20400
		STORM	NATURALE/MATTE	776749 ▲ FL-06000	776718 ◆ FL-01600	776722 ▲ FL-20400
		BARK	NATURALE/MATTE	776750 ▲ FL-06000	776719 ◆ FL-01600	776723 ▲ FL-20400

FLORIN OVERSIZE
magnUm

120x280/120x240/120x120/60x120

Specifica Imballo pag.
Packaging specifications on page
Spécifications d'emballage à page
Verpackungsdetail Seite
Especificaciones de embalaje a la página
158/159

6 mm 1/4" ↑↓

	COLOR	SURFACE	<p>4,6x60 1^{4/5"}x23^{5/8"}</p> <p>battiscopa</p>	
WOODSLATE LIFE		COTTON	NATURALE/MATTE	776724 ◆ FL-01800
		DOVE	NATURALE/MATTE	776725 ◆ FL-01800
		STORM	NATURALE/MATTE	776726 ◆ FL-01800
		BARK	NATURALE/MATTE	776727 ◆ FL-01800

3D: Si consiglia la posa con stucco epossidico per ambienti bagnati o sottoposti a forte umidità. / 3D: We recommend laying with epoxy putty for wet environments or those subject to strong humidity. / 3D: pose conseillée avec mortier époxy pour environnements très humides ou mouillés. / 3D: In nassen oder starker Feuchtigkeit ausgesetzten Bereichen empfiehlt sich die Verlegung mit Epoxidstuck. / 3D: En ambientes mojados o muy húmedos, se recomienda realizar la colocación con estuco epoxidico.

WOODSLATE LIFE	scatola - box			pallet		
	pz	mq	kg	box	mq	kg
20x120	6	1,44	28,66	24	34,56	720
60x120	2	1,44	27,73	30	43,20	860
60x60	3	1,08	21,49	40	43,20	890
30x60	6	1,08	21,49	40	43,20	890
wood arrow 9x60	16	0,77	15,28	60	46,08	950

WOODSLATE LIFE	scatola - box			pallet		
	pz	ml	kg	box	mq	kg
4,6x60 battiscopa	14	8,40	8,40	-	-	-

WOODSLATE LIFE OUTDOOR

Vantaggi tecnici - Technical advantages - Avantages techniques Technische Vorteile - Ventajas técnicas

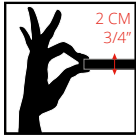

- Lastra monolitica compatta di spessore 2 cm squadrata e rettificata
- Compact monolithic slab 2 cm thick squared and rectified
- Dalle monolithique compacte de 2 cm d'épaisseur, équarrie et rectifiée
- Kompakte monolithische Platte, 2 cm dick, rechteckig und scharfkantig geschliffen
- Losa monolítica compacta de 2 cm de espesor, escuadrada y rectificada.

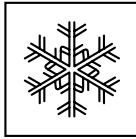

- INGELIVO
- FROST RESISTANT
- INGÉLIF
- FROSTBESTÄNDIG
- RESISTENTE A LA HELADA

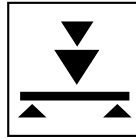

- ELEVATA RESISTENZA AI CARICHI STATICI
- HIGH STATIC LOAD RESISTANCE
- RÉSISTANCE ÉLEVÉE AUX CHARGES STATIQUES
- HOHE STATISCHE BELASTBARKEIT
- ELEVADA RESISTENCIA A LAS CARGAS ESTÁTICAS

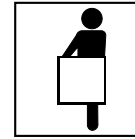

- FACILE DA POSARE
- EASY TO INSTALL
- FACILE À POSER
- VERLEGELEICHT
- FÁCIL DE COLOCAR



- ANTISCIVOLO R11
- ANTI SLIP R11
- ANTIDÉRAPANT R11
- RUTSCHFEST R11
- ANTIDESLIZANTE R11

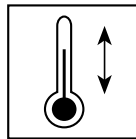

- RESISTENTE AGLI SBALZI TERMICI
- THERMAL SHOCK RESISTANT
- RÉSISTANT AUX ÉCARTS THERMIQUES
- TEMPERATURWECHSELBESTÄNDIG
- RESISTENTE A LAS OSCILACIONES TÉRMICAS



- FACILE DA PULIRE
- EASY TO CLEAN
- FACILE À NETTOYER
- REINIGUNGSLEICHT
- FÁCIL DE LIMPIAR

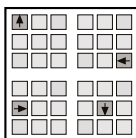

- RIMOVIBILE E RIUTILIZZABILE
- REMOVABLE AND REUSABLE
- DÉMONTABLE ET RÉUTILISABLE
- ENTFERNBAR UND WIEDERVERWENDBAR
- DESMONTABLE Y REUTILIZABLE



- INATTACCABILE DA AGENTI CHIMICI E MUFFE
- IMPERVIOUS TO ATTACK BY CHEMICALS OR MOULD
- RÉSISTANT AUX AGENTS CHIMIQUES ET AUX MOISSISSURES
- UNANGREIFBAR DURCH CHEMISCHE STOFFE UND SCHIMMEL
- RESISTENTE A LOS AGENTES QUÍMICOS Y A LOS MOHOS

Applicazioni - Applications - Applications - Verlegung - Aplicaciones

- Posa diretta su erba
- Direct installation on grass
- Pose direct sur de l'herbe
- Verlegung direkt auf Rasen
- Colocación directa sobre hierba

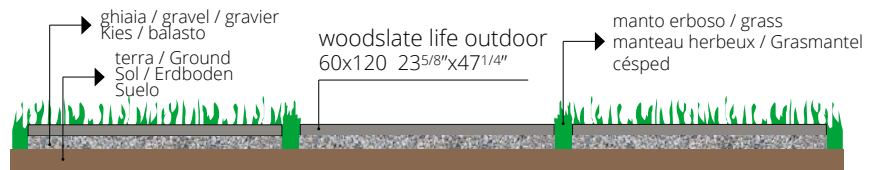

- Posa diretta su ghiaia
- Direct installation over gravel
- Pose direct sur du gravier
- Verlegung direkt auf Kies
- Colocación directa sobre grava



- Posa su massetto cementizio
- Installation on sand-cement screed
- Pose sur chape ciment
- Verlegung auf Zement-Unterbetonblock
- Colocación sobre contrapiso de hormigón

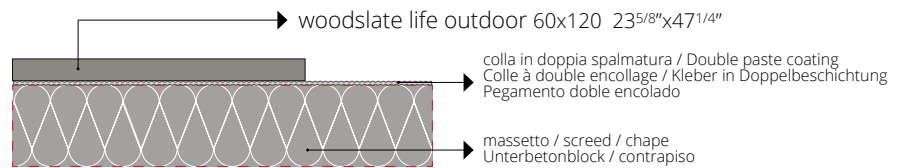

- Posa su piedini fissi o regolabili
- Installation on fixed or adjustable feet
- Pose sur pieds fixes ou réglables
- Verlegung auf feststehende oder regulierbare Füße
- Colocación sobre pies fijos o regulables

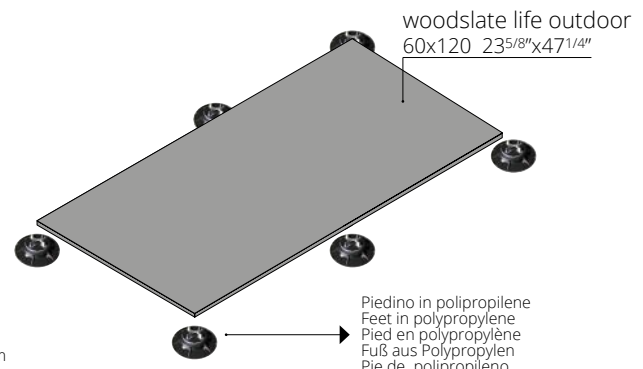

Per le specifiche di utilizzo dei sistemi sopraelevati vedi il sito florim.com
For the specifics on use of raised systems visit the site florim.com
Pour les caractéristiques d'utilisation des systèmes surélevés, voir le site florim.com
Für die Nutzungsbedingungen der Doppelbodensysteme siehe Webseite florim.com
Para las especificaciones de empleo de los sistemas sobreelevados consulte el sitio web florim.com

Le lastre ceramiche sono sottoposte a un trattamento di compattazione termica che assicura resistenza e durata nel tempo. Il bassissimo assorbimento d'acqua rende perciò il materiale ingelivo. Ciò può comportare ristagni d'acqua superficiali anche per materiale installato a regola d'arte. / Ceramic tiles undergo a compacting thermal treatment that ensures resistance and durability. The low level of water absorption makes the slabs frost resistant. This could result in superficial water stagnations even if materials are installed in a workmanlike manner. / Les carreaux de céramique subissent un traitement thermique de compactage qui assure résistance et durabilité. Le bas niveau d'absorption d'eau rend les dalles résistant au gel. Il pourrait en résulter des stagnations d'eau superficielles, même si les dalles ont été installées dans les règles de l'art. / Die Keramikplatten werden einer thermischen Verdichtung unterzogen, welche die Widerstandsfähigkeit und Langlebigkeit sichert. Die extrem niedrige Wasseraufnahme macht das Material frostsicher. Die hohe Materialdichte kann, auch bei einer perfekten Verlegung, eine längere Abtrochnungszeit von angestauretem Wasser zur Folge haben. / Las baldosas cerámicas se someten a un tratamiento de compactación térmica que asegura resistencia y durabilidad. La baja absorción de agua hace que las baldosas resistan al hielo. Esto podría resultar en estancamientos superficiales de agua, incluso si los materiales están instalados según las reglas del arte.

COTTON



DOVE



**R11
CLASSE C**

DCOF >
0,42 Wet

20 mm 3/4" ↑↓

STORM



BARK



GRES FINE PORCELLANATO

FINE PORCELAIN STONEWARE/GRES CERAME FIN/FEINSTEINZEUG-KOLLEKTIONEN/GRES PORCELANICO FINO
SQUADRATO - SQUARED - EQUARRI - REKTIFIZIERT - ESCUADRADO

20 mm 3/4" ↑↓

	COLOR	SURFACE	60x120 23 ^{5/8"} x47 ^{1/4"}	
WOODSLATE LIFE		COTTON	GRIP	776387 ■ FL-09100
		DOVE	GRIP	776388 ■ FL-09100
		STORM	GRIP	776389 ■ FL-09100
		BARK	GRIP	776390 ■ FL-09100



Product Certification
BUREAU VERITAS
Certification

Recycled material content certification

ISO 10545-4	RESISTENZA ALLA FLESSIONE IN N/mm ² N/mm ² FLEXURAL STRENGTH TEST / RESISTANCE A LA FLEXION EN N/mm ² / BIEGEFESTIGKEIT IN N/mm ² / RESISTENCIA A LA FLEXION EN N/mm ²	valore medio 52 N/mm ²
	Forza di rottura in N (sp. > 7,5 mm) Breaking strength in N (thickness > 7,5 mm) / Force de rupture en N (esp. > 7,5 mm) / Bruchlast in N (Dicke > 7,5 mm) / Fuerza de rotura en N (gr. > 7,5 mm)	valore medio 14000 N

PEZZI SPECIALI

Special trims/Pièces spéciales/Formstücke
Piezas especiales
pag 150/151

WOODSLATE LIFE	scatola - box			pallet		
	pz	mq	kg	box	mq	kg
60x120 20mm	1	0,72	32,26	30	21,60	1000

OUTDOOR 20mm PEZZI SPECIALI

SPECIAL TRIMS
PIÈCES SPÉCIALES
FORMSTÜCKE
PIEZAS ESPECIALES

CARATTERISTICHE TECNICHE

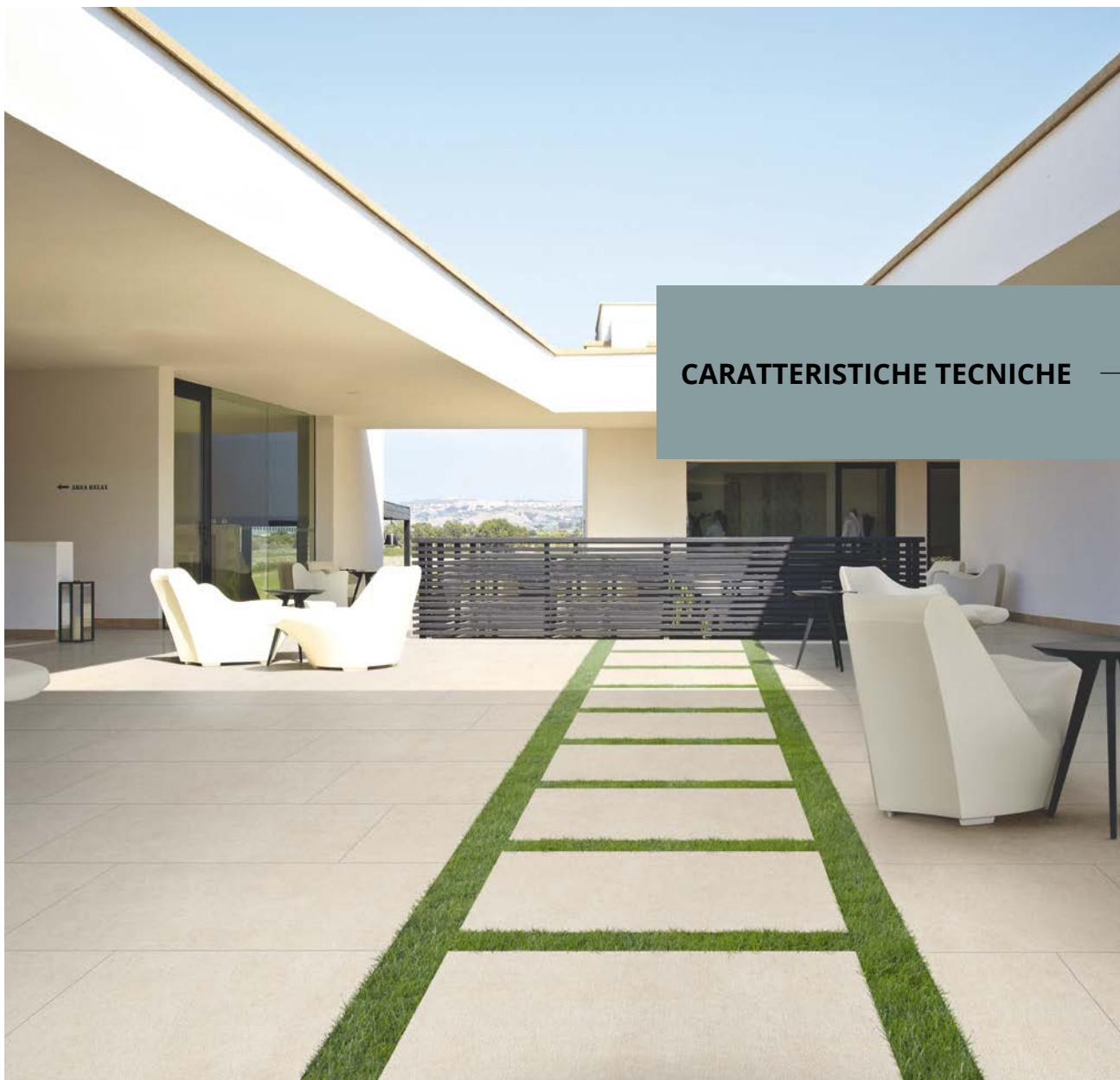



TECHNICAL FEATURES
CARACTÉRISTIQUES TECHNIQUES
TECHNISCHE EIGENSCHAFTEN
CARACTERÍSTICAS TÉCNICAS

Pezzi speciali Outdoor 20mm

Special trims/Pièces spèciales/Formstüke / Piezas especiales

Collections:

Maps - Elemental stone - Natural stone

Artifact - Rock salt - Match-up - Woodslate life

Gradino toro

30x60x2 11 4/5" x 23 5/8" x 4/5" _759146 ▲ FL-06400

40x80x2 15 3/4" x 31 1/2" x 4/5" _753647 ▲ FL-11300

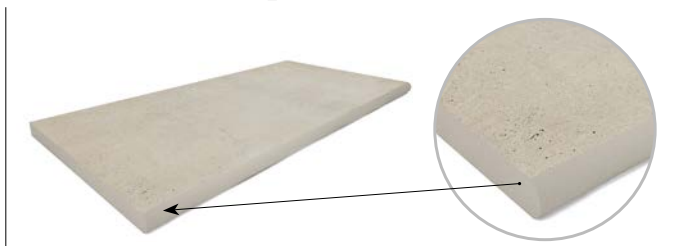

Gradino doppio toro

30x60x2 11 4/5" x 23 5/8" x 4/5" _759148 ▲ FL-11300

40x80x2 15 3/4" x 31 1/2" x 4/5" _753653 ▲ FL-19400

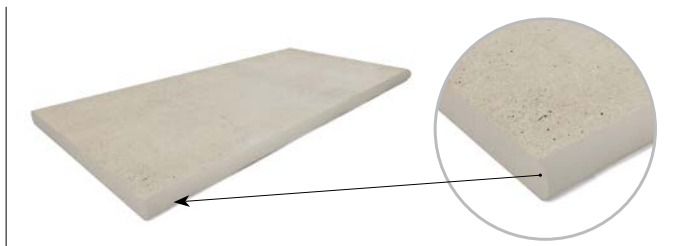

Gradino toro con gocciolatoio

30x60x2 11 4/5" x 23 5/8" x 4/5" _759147 ▲ GR-02050

40x80x2 15 3/4" x 31 1/2" x 4/5" _753650 ▲ FL-15600

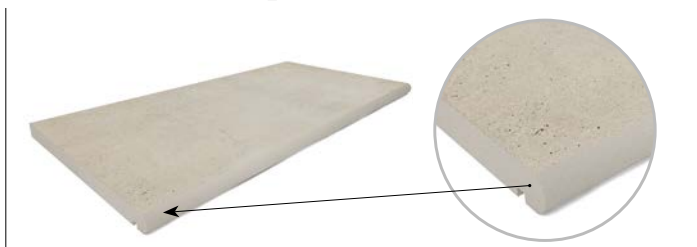

Gradino doppio toro con gocciolatoio

30x60x2 11 4/5" x 23 5/8" x 4/5" _759149 ▲ FL-15600

40x80x2 15 3/4" x 31 1/2" x 4/5" _753656 ▲ FL-15600



PEZZI SPECIALI OUTDOOR 20mm	scatola - box			pallet		
	pz	mq	kg	box	mq	kg
30x60 gradino toro	1	0,18	10,00	-	-	-
40x80 gradino toro	1	0,32	17,10	-	-	-
30x60 gradino toro con gocciolatoio	1	0,18	10,00	-	-	-
40x80 gradino toro con gocciolatoio	1	0,32	17,10	-	-	-
30x60 gradino doppio toro	1	0,18	10,00	-	-	-
40x80 gradino doppio toro	1	0,32	17,10	-	-	-
30x60 gradino doppio toro con gocciolatoio	1	0,18	10,00	-	-	-
40x80 gradino doppio toro con gocciolatoio	1	0,32	17,10	-	-	-

Collections:

Maps - Elemental stone - Natural stone - Artifact - Rock salt - Match-up -Woodslate life

Elemento ad Elle Angolo SX

30x60x8 11^{4/5"}x23^{5/8"}x3^{1/7"}_759152 ▲ FL-14500

40x80x8 15^{3/4"}x31^{1/2"}x3^{1/7"}_753858 ▲ FL-19900

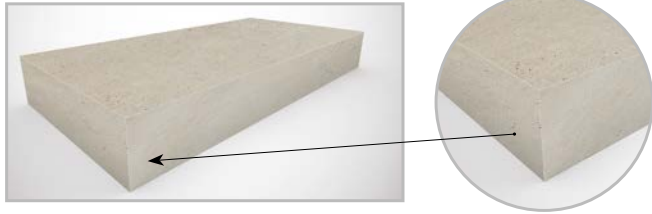

Elemento ad Elle Angolo SX

60x60x8 23^{5/8"}x23^{5/8"}x3^{1/7"}_759155 ▲ FL-19900

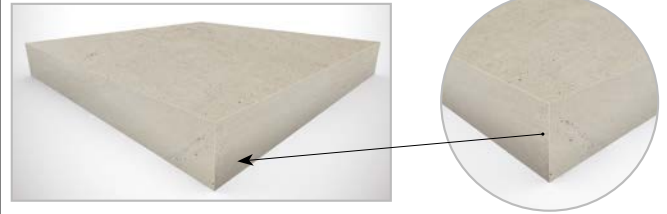

Elemento ad Elle

30x60x8 11^{4/5"}x23^{5/8"}x3^{1/7"}_759150 ▲ FL-09300

40x80x8 15^{3/4"}x31^{1/2"}x3^{1/7"}_753856 ▲ FL-14500

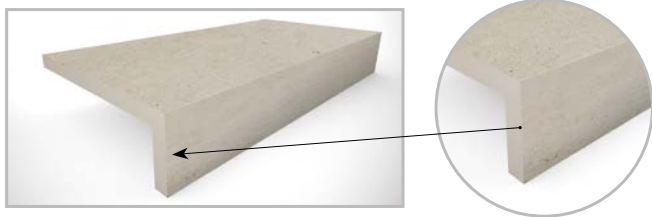

Elemento ad Elle

60x60x8 23^{5/8"}x23^{5/8"}x3^{1/7"}_759153 ▲ FL-14000

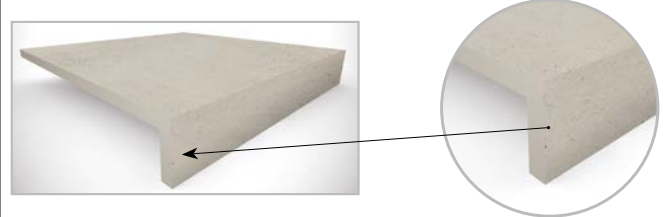

Elemento ad Elle Angolo DX

30x60x8 11^{4/5"}x23^{5/8"}x3^{1/7"}_759151 ▲ FL-14500

40x80x8 15^{3/4"}x31^{1/2"}x3^{1/7"}_753857 ▲ FL-19900

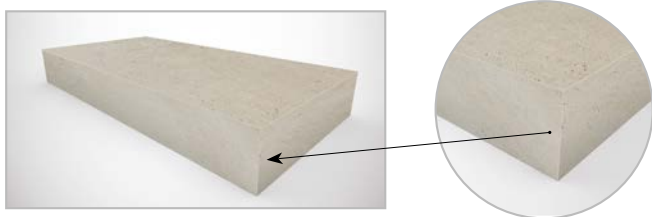

Elemento ad Elle Angolo DX

60x60x8 23^{5/8"}x23^{5/8"}x3^{1/7"}_759154 ▲ FL-19900

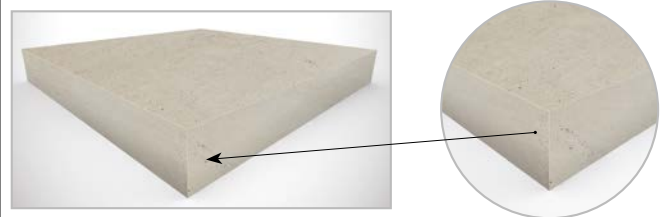

Pezzi speciali e fondo possono differire in termini di tonalità, il bordo può presentare stratificazioni di tonalità diverse.

Special pieces and field tiles may come in different shades, the slab's edge may show layers of differing hues.
 Il peut y avoir des différences de tonalités entre les pièces spéciales et le fond, le bord pourrait présenter des stratifications de tonalités différentes.
 Die Formteile können farblich von der Grundplatte abweichen, ihre Kanten können Schichtungen in unterschiedlichen Farbtönen aufweisen.
 Piezas especiales y bases pueden diferir en términos de tonalidad, el borde puede presentar estratificaciones de diferente tonalidad.

PEZZI SPECIALI OUTDOOR 20mm	scatola - box			pallet		
	pz	mq	kg	box	mq	kg
30x60x8 elemento ad elle angolo sx	1	0,18	10,10	-	-	-
40x80x8 elemento ad elle angolo sx	1	0,32	17,10	-	-	-
30x60x8 elemento ad elle	1	0,18	10,10	-	-	-
40x80x8 elemento ad elle	1	0,32	17,10	-	-	-
30x60x8 elemento ad elle angolo dx	1	0,18	10,10	-	-	-
40x80x8 elemento ad elle angolo dx	1	0,32	17,10	-	-	-
60x60x8 elemento ad elle angolo sx	1	0,36	20,10	-	-	-
60x60x8 elemento ad elle	1	0,36	20,10	-	-	-
60x60x8 elemento ad elle angolo dx	1	0,36	20,10	-	-	-

BORDO VASCA

SWIMMING POOL EDGE

BORD DE PISCINE

BECKENRAND

BORDE DE LA TINA



CARATTERISTICHE TECNICHE



TECHNICAL FEATURES
CARACTÉRISTIQUES TECHNIQUES
TECHNISCHE EIGENSCHAFTEN
CARACTERÍSTICAS TÉCNICAS

WAVE/SPECIALPIECES

BORDO VASCA / SWIMMING POOL EDGE / BORD DE PISCINE
BECKENRAND / BORDE DE LA TINA

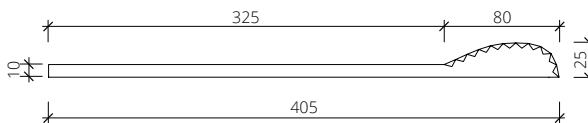
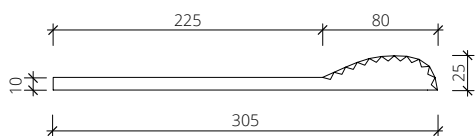

BORDO PER PISCINA "WAVE"

Rivoluzionario pezzo speciale che, attraverso l'accostamento di una serie di listelli opportunamente conformati su un lato del pezzo, rende ottimale la tracimazione, il contenimento dell'acqua, nonché l'appiglio manuale. La flessibilità progettuale di questo pezzo consente di realizzare bordi con diversi materiali Florim selezionati tra le serie che presentano le più elevate proprietà antiscivolo a piedi nudi (classe A+B+C, rif. norma DIN 51097).

"WAVE" SWIMMING POOL EDGE

Revolutionary border tile that, by placing together a set of suitably shaped strips on one side of the tile, makes an efficient overflow, containing the water and also offering a hand-grip. The flexibility of the design of this tile enables edges to be created with different Florim materials selected from the ranges that have the highest barefoot slip-resistance ratings (Class A+B+C, according to DIN 51097 standard).

BORD POUR PISCINE « WAVE »

Pièce spéciale révolutionnaire qui, grâce à la juxtaposition d'une série de listels dûment disposés sur un côté de la pièce, optimise le débordement, le confinement de l'eau, ainsi que le point d'accroche avec les mains. La flexibilité de conception de cette pièce permet de réaliser des bords avec différents matériaux Florim sélectionnés parmi les séries dotées des plus hautes propriétés antidérapantes pieds nus (classe A+B+C, réf. norme DIN 51097).

BECKENRANDSTEIN "WAVE"

Ein revolutionäres Spezialteil, das durch das Aneinandersetzen einer Reihe von Leisten, die an einer Seite des Spezialteils zweckmäßig geformt sind, eine ausgezeichnete Überflutung, Wassereindämmung und Griffkante bietet. Die flexible Projektanpassung dieses Spezialteils erlaubt die Gestaltung von Beckenrändern mit verschiedenen Florim-Materialien, ausgewählt unter den Produktserien mit der höchsten Barfuß-Rutschfestigkeit (Klasse A+B+C, Bezugsnorm DIN 51097).

BORDE PARA PISCINA «WAVE»

Pieza especial revolucionaria que se remata por un lado con una serie de listones de forma especial, para ofrecer un desbordamiento y retención del agua óptimos, así como un excelente asidero manual. La flexibilidad de diseño de esta pieza permite realizar bordes con varios materiales de Florim, seleccionados entre las series que presentan las más altas propiedades antideslizantes con pies descalzos (clase A+B+C, ref. norma DIN 51097).

OCEAN/SPECIALPIECES

BORDO VASCA / SWIMMING POOL EDGE / BORD DE PISCINE
BECKENRAND / BORDE DE LA TINA

OCEAN LINEARE



32x60 12^{3/5"}x23^{5/8"}

762881

▲ FL-16700

OCEAN ANGOLO AE



30,5x30,5 12"x12"

762891

▲ FL-19400

OCEAN ANGOLO AI 45°



32x60x60 12^{3/5"}x23^{5/8"}x23^{5/8"}

762886

▲ FL-36500

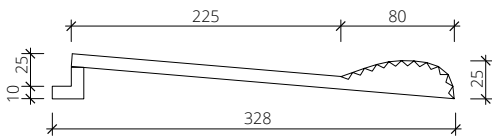

BORDO PER PISCINA "OCEAN"

Innovativo e rivoluzionario pezzo speciale progettato appositamente per essere utilizzato come bordo piscina con sistema ad acqua traboccante a sfioro. E' composto da un pezzo che, attraverso l'accostamento di una serie di listelli opportunamente conformati su un lato del pezzo, rende ottimale la trascinazione, il contenimento dell'acqua, nonché l'appiglio manuale. La flessibilità progettuale di questo pezzo consente di realizzare bordi con diversi materiali Florim selezionati tra le serie che presentano le più elevate proprietà antiscivolo a piedi nudi (classe A+B+C, rif. norma DIN 51097). Questo pezzo speciale comprende anche l'angolare in porcellanato per appoggio e contenimento griglia.

"OCEAN" SWIMMING POOL EDGE

Innovative, revolutionary border tile specially designed to be used as a swimming pool edge with overflow system. It comprises a piece that, by placing together a set of suitably shaped strips on one side of the tile, makes an efficient overflow, containing the water and also offering a hand-grip. The flexibility of the design of this tile enables edges with different Florim materials to be created, selecting them from the ranges that have the highest barefoot slip-resistance ratings (Class A+B+C, according to DIN 51097 standard). This special piece also includes the porcelain stoneware corner element for setting and containing the grating.

BORD POUR PISCINE « OCEAN »

Pièce spéciale innovante et révolutionnaire spécialement conçue pour être utilisée comme bord de piscine à débordement avec système de trop-plein. Grâce à la juxtaposition d'une série de listels dûment disposés sur un de ses côtés, cette pièce, optimise le débordement, le confinement de l'eau, ainsi que le point d'accroche avec les mains. La flexibilité de conception de cette pièce permet de réaliser des bords avec différents matériaux Florim sélectionnés parmi les séries dotées des plus hautes propriétés antidérapantes pieds nus (classe A+B+C, réf. norme DIN 51097). Cette pièce spéciale comprend également une pièce d'angle en grès cérame pour le support et le confinement de la grille.

BECKENRANDSTEIN "OCEAN"

Dieses innovative und revolutionäre Spezialteil wurde speziell für die Verwendung als Rand für Schwimmbecken mit Wasserüberlauftrinne entwickelt. Es besteht aus einem Teil, das durch das Aneinandersetzen einer Reihe von Leisten, die an einer Seite des Teils zweckmäßig geformt sind, eine ausgezeichnete Überflutung, Wassereindämmung und Griffkante bietet. Die flexible Projektanpassung dieses Spezialteils erlaubt die Gestaltung von Beckenrändern mit verschiedenen Florim-Materialien, ausgewählt unter den Produktserien mit der höchsten Barfuß-Rutschfestigkeit (Klasse A+B+C, Bezugsnorm DIN 51097). Dieses Spezialteil enthält auch das Eckstück aus Feinsteinzeug zur Aufnahme des Rostes.

BORDE PARA PISCINA «OCEAN»

Pieza especial, innovadora y revolucionaria, diseñada específicamente para usarse como borde de piscina con sistema de agua desbordante. Consta de una pieza que se remata por un lado con una serie de listones de forma especial, para ofrecer un desbordamiento y retención del agua óptimos, así como un excelente asidero manual. La flexibilidad de diseño de esta pieza permite realizar bordes con varios materiales de Florim, seleccionados entre las series que presentan las más altas propiedades antideslizantes con pies descalzos (clase A+B+C, ref. norma DIN 51097). Esta pieza especial también incluye la pieza angular de porcelánico de apoyo y sujeción de la rejilla.

CARATTERISTICHE - VANTAGGI TECNICI

1. Modularità a base 60/80 cm (in base alla collezione scelta).
2. Facilità di posa, con collanti di normale uso per la ceramica.
3. Elevata leggerezza.
4. Alta resistenza meccanica ai carichi.
5. Sicurezza allo scivolamento.
6. Costanza e precisione dimensionale.
7. Ergonomia che facilita l'appiglio manuale.
8. Conformazione che ottimizza la tracimazione e il contenimento dell'acqua.
9. Massima igiene.
10. Totale impermeabilità.
11. Possibilità di realizzazione con diverse collezioni antiscivolo Florim.
12. Ridotta incidenza nel costo complessivo della vasca.
13. Il taglio dei pezzi in cantiere, deve essere fatto con sistemi adeguati (es. taglio ad acqua con disco diamantato).

TAGLI

E' possibile fornire pezzi tagliati a misura di varie forme e dimensioni. Prezzi e condizioni di vendita sono da stabilire, con specifica offerta da parte della divisione "FLORIM SOLUTIONS".

CARACTÉRISTIQUES - AVANTAGES TECHNIQUES

1. Modularité à la base 60/ 80 cm (en fonction de la collection choisie)
2. Facilité de pose, avec des adhésifs à usage normal pour la céramique.
3. Légèreté élevée.
4. Haute résistance mécanique aux charges.
5. Antidérapant.
6. Constance et précision dimensionnelles.
7. Ergonomie qui facilite la prise manuelle.
8. Conformation qui optimise le débordement et le confinement de l'eau.
9. Hygiène maximale.
10. Etanchéité totale.
11. Possibilité de mise en œuvre avec diverses collections Anti dérapant Florim.
12. Incidence réduite dans le coût global de la piscine.
13. La découpe des pièces sur le chantier doit être effectuée avec des systèmes adéquats (par ex. découpe à eau avec disque diamanté).

PIÈCES COUPÉES

Il est possible de fournir des pièces coupées sur mesure de diverses formes et dimensions. Prix et conditions de vente à établir avec une offre spécifique de la part de la division «FLORIM SOLUTIONS».

CARACTERÍSTICAS - VENTAJAS TÉCNICAS

1. Modularidad en base a 60/ 80 cm (según la colección elegida)
2. Facilidad de colocación, con encolados de uso normal para cerámicos.
3. Elevada ligereza.
4. Alta resistencia mecánica a las cargas.
5. Seguridad contra el deslizamiento.
6. Constancia y precisión dimensional.
7. Ergonomía que facilita el agarre manual.
8. Configuración que optimiza el desbordamiento y la contención del agua.
9. Máxima higiene.
10. Total impermeabilidad.
11. Posibilidad de realización con las distintas colecciones de antideslizantes Florim.
12. Reducida incidencia en el coste total de la tina.
13. El corte de las piezas en las obras se debe realizar con sistemas adecuados (por ejemplo: corte de agua con disco diamantado).

CORTES

Es posible proveer piezas cortadas a la medida de varias formas y dimensiones. Los precios y condiciones de venta se deben fijar mediante una oferta específica de la división "FLORIM SOLUTIONS".

TECHNICAL CHARACTERISTICS - ADVANTAGES

1. Modularity with 60/ 80 CM (based on the chosen collection)
2. Easy to lay with adhesives normally used for ceramic materials.
3. Ultra-light weight.
4. High mechanical load resistance.
5. Non-slip safety.
6. Dimensional constancy and precision.
7. Ergonomics that facilitate manual gripping.
8. Conformation that optimises the overflow and containment of water.
9. Maximum hygiene.
10. Total impermeability.
11. Possibility to create using different Florim antislip collections.
12. Reduced incidence on the total cost of the pool.
13. The cutting of the pieces on the work site must be done using suitable systems (e.g. water cut with diamond disk).

CUTS

It is possible to supply pieces cut to measure in various shapes and sizes. Prices and sales conditions are to be stipulated with a specific offer by the FLORIM SOLUTIONS Division.

MERKMALE - TECHNISCHE VORZÜGE

1. Modularität auf der Basis von 60/80 cm (basierend auf der ausgesuchten Kollektion)
2. Einfache Verlegung mit den üblichen Klebern für Keramik.
3. Äußerste Leichtigkeit.
4. Hohe mechanische Belastungsfestigkeit.
5. Rutschfestigkeit.
6. Maßbeständigkeit und -genauigkeit.
7. Ergonomische Form, die das Greifen mit der Hand erleichtert.
8. Beschaffenheit, die den Überlauf und die Eindämmung des Wassers optimiert.
9. Maximale Hygiene.
10. Vollkommene Wasserundurchlässigkeit.
11. Möglichkeit der Herstellung mit verschiedenen rutschfest Serien von Florim.
12. Geringe Auswirkung auf die Gesamtkosten des Beckens.
13. Das Schneiden der Teile an der Baustelle hat mit geeigneten Systemen (z.B. Wasserstrahlschneiden mit Diamantscheibe) zu erfolgen.

ZUSCHNITT

Es können nach Maß zugeschnittene Teile in verschiedenen Formen und Größen geliefert werden. Preise und Verkaufsbedingungen sind in speziellem Angebot der Abteilung "FLORIM SOLUTIONS" festzulegen.

WAVE/OCEAN/PACKAGES

WAVE LINEARE	30,5x60
WAVE ANGOLO AE	30,5x30,5
WAVE ANGOLO AI 45°	30,5x60x60
OCEAN LINEARE	32x60
OCEAN ANGOLO AE	30,5x30,5
OCEAN ANGOLO AI 45°	32x60x60

BOXES



PZ	MQ	KG
2	-	8,60
2	-	4,90
1	-	6,50
2	-	9,20
2	-	5,50
1	-	6,80

PALLETS





PZ	MQ	KG
-	-	-
-	-	-
-	-	-
-	-	-
-	-	-
-	-	-

FLORIM OVERSIZE
magnUm[®]

IMBALLI
PACKAGING
EMBALLAGES
VERPACKUNG
EMBALAJES

TABELLA IMBALLI

PACKAGE TABLE/TABLEAU DE EMBALLAGES/TABELLE FORMATE/TABLA DE LOS EMBALAJES
#6 SPESSORE / THICKNESS/ÉPAISSEUR/STÄRKE/ESPESOR

			 BOXES				 PALLET		
			ML	PZ	MQ	KG	BOX	MQ	KG
	80x80	31 ^{1/2"} x31 ^{1/2"}	-	3	1,92	27,80	40	76,80	1140
	60x120	23 ^{5/8"} x47 ^{1/4"}	-	3	2,16	31,30	30	64,80	960
MOSAICO 1,5x3	30x30	11 ^{4/5"} x11 ^{4/5"}	-	11	1,00	16,50	-	-	-
MOSAICO 7,5x7,5	30x30	11 ^{4/5"} x11 ^{4/5"}	-	11	1,00	16,50	-	-	-
BATTISCOPIA	4,6x60	1 ^{4/5"} x23 ^{5/8"}	14,40	24	-	8,60	-	-	-

*Le lastre sono contenute in scatole da 2 pezzi ciascuna / Packing for this item is 2 slabs per box / Les plaques sont contenues dans des boîtes de 2 pièces chacune .
Die Platten sind in Kartons zu je 2 Stück verpackt. / Las baldosas están empaquetadas en cajas de 2 piezas cada una.



°per spedizioni > 12 scatole / for shipments > 12 boxes / pour les expéditions > 12 boîtes / für Versandmengen > 12 Schachteln / para envíos > 12 cajas

°°per spedizioni ≤ 12 scatole / for shipments ≤ 12 boxes / pour les expéditions ≤ 12 boîtes / für Versandmengen ≤ 12 Schachteln / para envíos ≤ 12 cajas

TABELLA IMBALLI

PACKAGE TABLE/TABLEAU DE EMBALLAGES/TABELLE FORMATE/TABLA DE LOS EMBALAJES

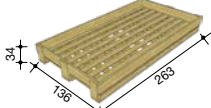
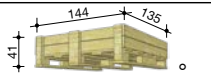
≠6 SPESSORE / THICKNESS/ÉPAISSEUR/STÄRKE/ESPOSOR

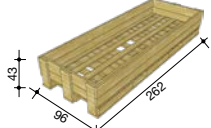
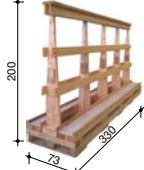
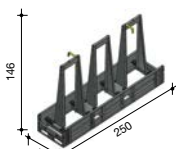
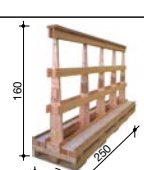
TIPO TYPE	formato LASTRA SLAB size	LASTRA SLAB		CASSA vuota empty CRATE			CASSA piena full CRATE	CAVALLETTO vuoto empty A-Frame			CAVALLETTO pieno full A-Frame
		MQ	KG	PZ	MQ	KG	KG	PZ	MQ	KG	KG
	B 120x280 47 ^{1/4} "x110 ^{1/4} "	3,36	48,65	20	67,20	90,00	1063	-	-	-	-
	C 120x240 47 ^{1/4} "x94 ^{1/2} "	2,88	41,70	20	57,60	107,00	941	-	-	-	-
	D 120x120 47 ^{1/4} "x47 ^{1/4} "	1,44	20,85	24*	34,56	50,00	550	-	-	-	-
	E 120x120 47 ^{1/4} "x47 ^{1/4} "	1,44	20,70	48*	69,12	70	1065,1	-	-	-	-
	F 80x240 31 ^{1/2} "x94 ^{1/2} "	1,92	27,80	30	57,60	97,00	931	-	-	-	-
	I 120x280 47 ^{1/4} "x110 ^{1/4} "	3,36	48,65	-	-	-	-	44	147,84	220,00	2360,6
	M 120x280 47 ^{1/4} "x110 ^{1/4} " Cavalletto in lamiera zincata Zinc-plated sheet A-frame	3,36	48,65	-	-	-	-	44	147,84	108,5	2249,1
	N 120x240 47 ^{1/4} "x94 ^{1/2} " Cavalletto in lamiera zincata Zinc-plated sheet A-frame	2,88	41,70	-	-	-	-	44	126,72	92,5	1941,5
	O 80x240 31 ^{1/2} "x94 ^{1/2} " Cavalletto in lamiera zincata Zinc-plated sheet A-frame	1,92	27,80	-	-	-	-	28	84,48	92,5	1325,5
	P 120x240 47 ^{1/4} "x94 ^{1/2} "	2,88	41,70	-	-	-	-	44	126,72	170,00	2004,8
	Q 80x240 31 ^{1/2} "x94 ^{1/2} "	1,92	27,80	-	-	-	-	44	84,48	170,00	1393,2

Listino IMBALLI / Price List PACKAGING

TIPO / TYPE	PREZZO / PRICE
B: CASSA / CRATE cm 145x292x35h - 57"x115"x13 ^{7/8} "	160,00 €
C: CASSA / CRATE cm 136x263x34h - 53 ^{1/2} "x103 ^{1/2} "x13 ^{2/5} "	160,00 €
D: CASSA / CRATE cm 135x144x41h - 53 ^{1/7} "x56 ^{2/3} "x16 ^{1/7} "	-
E: CASSA / CRATE cm 135x144x66h - 53 ^{1/7} "x56 ^{2/3} "x26"	-
F: CASSA / CRATE cm 96x262x43h - 37 ^{4/5} "x103 ^{1/7} "x17"	160,00 €
I: CAVALLETTO / A-FRAME cm 73x330x200h - 28 ^{3/4} "x130"x78 ^{3/4} "	360,00 €
M: CAVALLETTO / A-FRAME cm 75x290x146h - 29 ^{1/2} "x114 ^{1/6} "x57 ^{1/2} "	450,00 €
N/O: CAVALLETTO / A-FRAME cm 75x250x146h - 29 ^{1/2} "x98 ^{3/7} "x57 ^{1/2} "	380,00 €
P/Q: CAVALLETTO / A-FRAME cm 75x250x160h - 29 ^{1/2} "x98 ^{3/7} "x63"	280,00 €



FLORIM OVERSIZE
magnUm[®]

MODERN DESIGN
PERSPECTIVES ARE
CHANGING: AMAZING
SIZES IN A THICKNESS
OF JUST 6 MM,
LIGHT, VERSATILE
AND STRONG, WITH
EXTRAORDINARY
AESTHETIC APPEAL.

GRAPHICS

CRAYONS

MILK

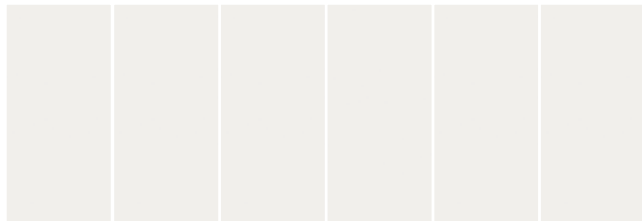

OLD LACE

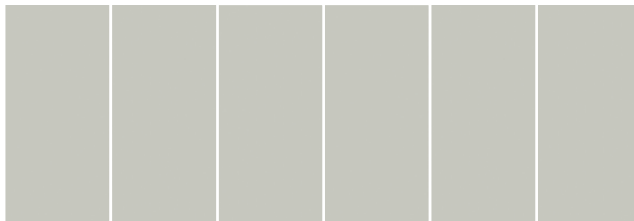

PRIMROSE

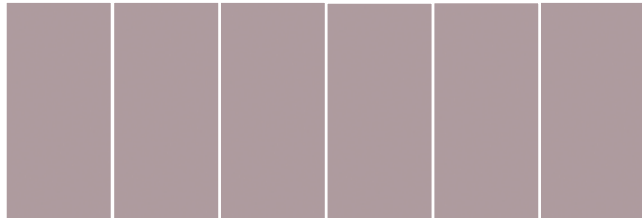

HAZELNUT

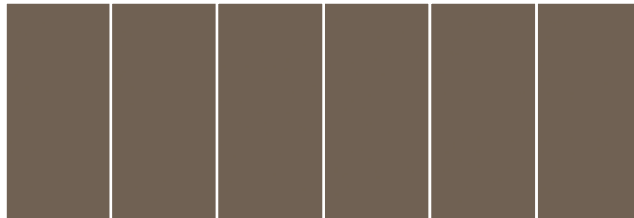

BUTTERCREAM



SKYLINE



MIST

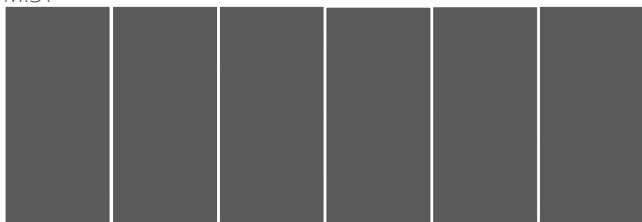

MOSS

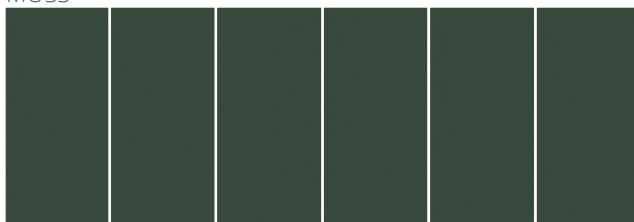

WOODSLATE LIFE

COTTON



DOVE

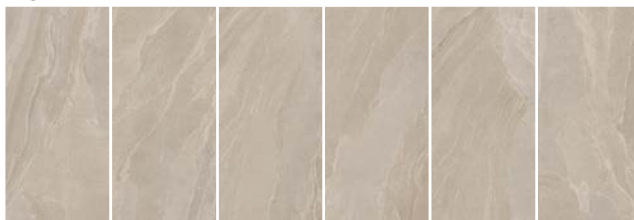

STORM



BARK



Le immagini riportate non rappresentano necessariamente il numero di grafiche del prodotto. Il numero di grafiche è variabile in funzione del formato e del colore di riferimento.
 Images do not necessarily represent the number of patterns in the product's range. The number of different patterns varies according to size and color of the item. / Les images reportées ne représentent pas forcément le nombre de graphismes du produit. Leur nombre varie en fonction du format et de la couleur choisie. / Die Abbildungen geben keine bindende Auskunft bzgl. der Anzahl verschiedener Grafiken. Die Anzahl der Grafiken ist abhängig von Format und Farbe der jeweiligen Kollektion. / Las imágenes mostradas no representan necesariamente el número de gráficas del producto. El número de gráficas varía en función del formato y del color.

TIMELESS

TIMELESS CALACATTA



TIMELESS AMANI GREY



TIMELESS CEPPO DI GRÈ



TIMELESS TRAVERTINO



ROCK SALT

WHITE GOLD



CELTIC GREY



DANISH SMOKE



MAUI GREEN



MATCH-UP

SUGAR



SUGAR MIX



COOKIE



COOKIE MIX



EARL GREY



EARL GREY MIX





CARATTERISTICHE TECNICHE











TECHNICAL FEATURES
CARACTÉRISTIQUES TECHNIQUES
TECHNISCHE EIGENSCHAFTEN
CARACTERISTICAS TÉCNICAS

6mm

TIMELESS - ROCK SALT

GRES PORCELLANATO SMALTATO / GLAZED PORCELAIN STONEWARE/GRES CÉRAMÉ ÉMAILLÉ/GLASIERTE FEINSTEINZEUG/GRES PORCELÁNICO ESMALTADO
SQUADRATO - SQUARED - EQUARRI - REKTIFIZIERT - ESCUADRADO

6 mm 1/4" 

CARATTERISTICHE TECNICHE - TECHNICAL CHARACTERISTICS - CARACTERISTIQUES TECHNIQUES - TECHNISCHE EIGENSCHAFTEN - CARACTERÍSTICAS TÉCNICAS									
	Prestrelle di ceramica pressate a secco. Caratteristiche di qualità secondo i test di controllo previsti dalla norma EN 14411-ISO 13006 Appendice G gruppo Bla GL / Dry-pressed ceramic tiles. Quality specifications, according to control tests of EN 14411-ISO 13006 Appendix G group Bla GL / Carreaux céramiques pressés à sec. Caractéristiques de qualité d'après les essais de contrôle norme EN 14411-ISO 13006 Appendice G groupe Bla GL / Trocken gepresste Keramikfliesen. / Qualitätseigenschaften nach Normen EN 14411-ISO 13006 Anhang G Gruppe Bla GL / Baldosas de cerámica prensadas en seco. Características de calidad según las Normas EN 14411-ISO 13006 Apéndice G grupo Bla GL.	PRESCRIZIONE STANDARD REQUIREMENTS PRESCRIPTIONS ANFORDERUNGEN PRESCRIPTION		RISULTATI TESTS TEST RESULTS RESULTATS DES ESSAIS PRÜFERERGEBNIS RESULTADOS TESTS				RIFERIMENTO NORMA REFERENCE STANDARD STANDARDWERT REFERENCIA NORMA	
		N ≥ 15 cm		TIMELESS		ROCK SALT			
		(%)	(mm)	naturale	lucido	naturale	lucido		
	LUNGHEZZA E LARGHEZZA: DEVIAZIONE AMMISSIBILE, IN %, DELLA DIMENSIONE MEDIA DI OGNI PIASTRELLA DALLA DIM. DI FABBRICAZIONE / LENGTH AND WIDTH: ADMITTED DEVIATION, IN %, OF THE AVERAGE SIZE OF EACH TILE FROM THE PRODUCTION DIMENSIONS / LONGUEUR ET LARGEUR : MARGE DE TOLÉRANCE, EN %, ENTRE LA DIMENSION MOYENNE DE CHAQUE CARREAU ET LA DIM. DE FABRICATION / LANGE UND BREITE: ZULÄSSIGE ABWEICHUNG DES DURCHSCHNITTMÄßES JEDER FLIESE VOM HERSTELLMAß IN PROZENTEN LARGO Y ANCHO: DESVIACIÓN ADMISIBILE, EN %, DEL TAMAÑO MEDIO DE CADA BALDOSA A PARTIR DEL TAMAÑO DE FABRICACIÓN	Squadrato ISO 13006	±0,3%	±1,0mm			±0,15%	ISO 10545-2	
	DEVIAZIONE AMMISSIBILE, IN PERCENTO, DELLO SPESORE MEDIO DI OGNI PIASTRELLA DALLA DIMENSIONE DI FABBRICAZIONE / ADMITTED DEVIATION, IN %, OF THE AVERAGE THICKNESS OF EACH TILE FROM THE PRODUCTION DIMENSIONS / MARGE DE TOLÉRANCE, EN POURCENTAGE, ENTRE L'ÉPAISSEUR MOYENNE DE CHAQUE CARREAU ET LA DIMENSION DE FABRICATION / ZULÄSSIGE ABWEICHUNG DER DURCHSCHNITTSDICKE JEDER FLIESE VOM HERSTELLMAß IN PROZENTEN / DESVIACIÓN ADMISIBILE, EN TANTO POR CIENTO, DEL GROSOR MEDIO DE CADA BALDOSA A PARTIR DEL TAMAÑO DE FABRICACIÓN	-	±5%	±0,5mm			±5%	ISO 10545-2	
	DEVIAZIONE MASSIMA DI RETTILINEARITÀ, IN PERCENTO, IN RAPPORTO ALLE DIMENSIONI DI FABBRICAZIONE CORRISPONDENTI / MAXIMUM STRAIGHTNESS DEVIATION, IN %, IN RELATION TO THE CORRESPONDING PRODUCTION DIMENSIONS / MARGE DE TOLÉRANCE DE RECTITUDE, EN POURCENTAGE, PAR RAPPORT AUX DIMENSIONS DE FABRICATION CORRÉSPONDANTES / ZULÄSSIGE HÖCHSTABWEICHUNG DER KANTENGERADHEIT IM VERHÄLTNIS ZU DEN ENTSPRECHENDEN HERSTELLMAßEN IN PROZENTEN / DESVIACIÓN MÁXIMA DE RECTITUD, EN TANTO POR CIENTO, EN RELACIÓN CON EL TAMAÑO DE FABRICACIÓN CORRÉSPONDIENTE	Squadrato ISO 13006	±0,3%	±0,8mm			±0,1%	ISO 10545-2	
	DEVIAZIONE MASSIMA DI ORTOGONALITÀ, IN PERCENTO, IN RAPPORTO ALLE DIMENSIONI DI FABBRICAZIONE CORRISPONDENTI / MAXIMUM RIGHT-ANGLE DEVIATION, IN %, IN RELATION TO THE CORRESPONDING PRODUCTION DIMENSIONS / MARGE DE TOLÉRANCE D'ANGULARITÉ, EN POURCENTAGE, PAR RAPPORT AUX DIMENSIONS DE FABRICATION / HÖCHSTABWEICHUNG DER RECHTWINKELGKEIT IM VERHÄLTNIS ZU DEN ENTSPRECHENDEN HERSTELLMAßEN IN PROZENTEN / DESVIACIÓN MÁXIMA DE LA ORTOGONALIDAD, EN TANTO POR CIENTO, EN RELACIÓN CON EL TAMAÑO DE FABRICACIÓN CORRÉSPONDIENTE	Squadrato ISO 13006	±0,3%	±1,5mm			±0,2%	ISO 10545-2	
	PLANARITÀ (CURVATURA DEL CENTRO, DELLO SPIGOLO E SVERGOLAMENTO) / FLATNESS (CURVING IN THE MIDDLE, CORNER AND WARPING) / PLANITÉ (COUREURE CENTRALE, DE L'ARÊTE ET GAUCHISSEMENT) / EBENFLÄCHIGKEIT (KRÜMMUNG DER MITTE, DER KANTE UND VERWINDUNG) / PLANITUD (CURVATURA DEL CENTRO, DE LA ARISTA Y ABARQUILLAMIENTO)	Squadrato ISO 13006	±0,4%	±1,8mm			±0,2%	ISO 10545-2	
	QUALITÀ DELLA SUPERFICIE / SURFACE QUALITY / QUALITÉ DE LA SURFACE / QUALITÄT DER OBERFLÄCHE CALIDAD DE LA SUPERFICIE	Il 95% min delle piastrelle deve essere esente da difetti visibili. At least 95% of the tiles must be free from visible flaws. 95% min des carreaux ne doivent présenter aucun défaut visible. Mindestens 95% der Fliesen müssen frei von sichtbaren min. El 95% de las baldosas tiene que estar exento de defectos visibles			CONFORME/CONFORMING CONFORME/KONFORM CONFORME			ISO 10545-2	
	MASSA D'ACQUA ASSORBITA IN % / % WATER ABSORPTION - MASSE D'EAU ABSORBÉE EN % WASSERAUFNAHME IN % / MASA DE AGUA ABSORBIDA EN %		< 0,5%				valore medio 0,08%	ISO 10545-3	
	FORZA DI ROTTURA IN N (sp. < 7,5 mm) - BREAKING STRENGTH IN N (thickness < 7,5 mm) / FORCE DE RUPTURE EN N (ép. < 7,5 mm) / BRUCHLAST IN N (Dicke < 7,5 mm) / FUERZA DE ROTTURA EN N (gr. < 7,5 mm)		≥ 700				valore medio 1350 Newton	ISO 10545-4	
	RESISTENZA ALLA FLESSIONE IN N/mm2 / N/mm2 FLEXURAL STRENGTH TEST / RÉSISTANCE A LA FLEXION EN N/mm2 / BIEGEFESTIGKEIT IN N/mm2 / RESISTENCIA A LA FLEXIÓN EN N/mm2		35 MIN.				valore medio 52 N/mm2	ISO 10545-4	
	RESISTENZA ALL'ABRASIONE DELLE PIASTRELLE SMALTATE / RESISTANCE TO ABRASION OF GLAZED TILES / RESISTANCE À L'ABRASION DES CARREAUX ÉMAILLÉS / TIEFENABRIEFESTIGKEIT GLASIERTER FLIESEN / RESISTENCIA A LA ABRASIÓN DE LAS BALDOSAS ESMALTADAS	come dichiarato dal produttore see manufacturer's declaration selon déclaration du producteur entsprechend der herstellereangaben tal como declara el fabricante			CALACATTA CLASSE 5 TRAVERTINO CLASSE 4 MARBIL CLASSE 4 AMANI GRAY CLASSE 3 CEPPO DI GRÉ CLASSE 4	WHITE GOLD CLASSE 5 CELTIC GREY CLASSE 4 DANISH SMOKE CLASSE 4 MALU GREEN CLASSE 4		ISO 10545-7	
	RESISTENZA AGLI SBALZI TERMICI / THERMAL SHOCKS RESISTANT / RÉSISTANCE AUX VARIATIONS THERMIQUES / TEMPERATURWECHSELBESTÄNDIGKEIT / RESISTENCIA AL CHOQUE TÉRMICO	Metodo di prova disponibile / Available testing method Méthode d'essai disponible / Verfügbare Prüfmethode Método de ensayo disponible			RESISTE - RÉSISTANT RÉSISTE - ERFÜLLT RESISTE			ISO 10545-9	
	RESISTENZA AL GELO / FROST RESISTANCE RÉSISTANCE AU GEL / FROSTSICHERHEIT / RESISTENCIA A LA HELADA	richiesta - required requisite - gefordert requerida			RESISTE - RÉSISTANT RÉSISTE - ERFÜLLT RESISTE			ISO 10545-12	
	RESISTENZA ALLE MACCHIE / RESISTANCE TO STAINING / RÉSISTANCE AUX TACHES / FLECKE- NABWEISEND / RESISTENCIA A LAS MANCHAS	Metodo di prova disponibile Available testing method Méthode d'essai disponible Verfügbare Prüfmethode Método de ensayo disponible			Classe 4	Classe 3	Classe 4-5	Classe 4	ISO 10545-14
	RILASCIO DI SOSTANZE PERICOLOSE / RELEASE OF HAZARDOUS SUBSTANCES / REJET DE SUBSTANCES DANGEREUSES / FREISETZUNG GEFÄHRLICHER STOFFE / LIBERACIÓN DE SU- STANCIAS PELIGROSAS CADMIO (in mg/dm2) - PIOMBO (in mg/dm2)	valore dichiarato per superfici GL con impieghi su piani di lavoro declared value for GL surfaces used on worktops / valeur déclarée pour surfaces GL utilisées sur plans de travail / angegebener wert für GL oberflächen zum gebrauch als arbeitsplatten / valor declarado para acabados GL utilizados para superficies de trabajo			CONFORME/CONFORMING CONFORME/KONFORM CONFORME			DM-1-2-2007-Reg- CE-1935-2004	
	RESISTENZA A BASSE CONCENTRAZIONI DI ACIDI E ALCALI / RESISTANCE TO LOW CONCENTRATIONS OF ACIDS AND ALKALIS. / RESISTANCE A BASSES CONCENTRATIONS D'ACIDES ET ALCALIS. / WIDERSTAND GEGEN NIEDRIGE KONZENTRATIONEN VON SÄUREN UND LAUGEN. / RESISTENCIA A BAJAS CONCENTRACIONES DE ÁCIDOS Y ALCALIS. /	come dichiarato dal produttore see manufacturer's declaration selon déclaration du producteur entsprechend der herstellereangaben tal como declara el fabricante			GLA	GLB	GLA	GLB	ISO 10545-13
	RESISTENZA AI PRODOTTI CHIMICI DI USO DOMESTICO E AGLI ADDITIVI PER PISCINA RESISTENCE TO DOMESTIC CHEMICAL PRODUCTS AND ADDITIVES FOR SWIMMING POOLS / RÉSISTANT AUX PRODUITS CHIMIQUES À USAGE DOMESTIQUE ET AUX ADDITIFS POUR PISCINE / WIDERSTAND GEGEN HAUSHALTSCHIMIKALIEN UND / SCHWIMMBADZUSATZSTOFFEN / RESISTENCIA A PRODUCTOS PARA LIMPIEZA DOMESTICA Y ADITIVOS PARA PISCINAS	MIN B			GA				
	RESISTENZA AL CAVILLIO DI PIASTRELLE SMALTATE / GLAZE CRAZING RESISTANCE - RÉSISTANCE AU TRESSAILLAGE POUR LES CARREAUX ÉMAILLÉS / WIDERSTAND GEGEN HAARRISSE VON GLASIERTEN FLIESEN - RESISTENCIA AL CUARTEADO DE LOS AZULEJOS ESMALTADOS	richiesta - required requisite - gefordert requerida			RESISTE - RÉSISTANT RÉSISTE - ERFÜLLT RESISTE				ISO 10545-11
	COEFFICIENTE D'ATTRITO (SCIVOLosità) / FRICTION COEFFICIENT (SLIPPERINESS) / COEFFICIENT DE FRICTION (GLISSEMENT) / REIBUNGSKOEFFIZIENT (SCHLUPFRIGKEIT) - COEFICIENTE DE ANTI DESPLAZAMIENTO /	-			6° ≤ α < 10° R9	-	10° ≤ α < 19° R10	-	DIN EN 16165 ANNEX B
					-	-	18° ≤ α < 24° classe B	-	DIN EN 16165 ANNEX A
					DCOF >0,42 wet	-	DCOF >0,42 wet	-	ANSI A 326.3











Per un effetto ottimale della posa, florim suggerisce di mantenere 2 mm di fuga per pose monoformato e 3 mm per combinare formati misti / For optimal installation results, florim recommends maintaining a joint of 2 mm 1/12" for single format installations and 3 mm 1/8" to combine mixed formats / Pour réaliser une pose parfaite, florim suggère de maintenir 2 mm de joint pour la pose des monoformats, et 3 mm pour les combinaisons de formats mixtes / Um einen optimalen effekt beim verlegen zu erzielen empfiehlt florim eine 2 mm fugge bei einformatigen verlegungen und 3 mm fugge bei formatkombinationen / Para lograr los máximos resultados en la posa del producto, florim aconseja 2 mm de junta enaplicaciones monoformato y 3 mm en combinaciones de formatos mixtos

CRAYONS - MATCH-UP - WOODSLATE LIFE

6 mm 1/4" ↑

GRES FINE PORCELLANATO/FINE PORCELAIN STONEWARE/GRES CERAME FIN/FEINSTEINZEUG-KOLLEKTIONEN/GRES PORCELANICO FINO
SQUADRATO - SQUARED - EQUARRI - REKTIFIZIERT - ESCUADRADO

CARATTERISTICHE TECNICHE - TECHNICAL CHARACTERISTICS - CARACTERISTIQUES TECHNIQUES - TECHNISCHE EIGENSCHAFTEN - CARACTERÍSTICAS TÉCNICAS

	Lastre in gres fine porcellanato non smaltato. Piastrelle di ceramica pressate a secco. Caratteristiche di qualità secondo i test di controllo previsti dalla norma EN 14411-ISO 13006 Appendice G gruppo Bia UGL. / Unglazed porcelain stoneware slabs. Dry-pressed ceramic tiles. Quality specifications, according to control tests of EN 14411-ISO 13006 Appendix G group Bia UGL. / Dalles en grès cérame fin non émaillé. Carreaux céramiques pressés à sec. Caractéristiques de qualité d'après les essais de contrôle norme EN 14411-ISO 13006 Appendice G groupe Bia UGL. / Nicht glasierte und vollständig gesinterte Feinsteinzeugplatten. Trocken gepresste Keramikfliesen. Qualitätseigenschaften nach Normen EN 14411-ISO 13006 Anhang G Gruppe Bia UGL. / Planchas de gres porcelánico fino no esmalado. Baldosas de cerámica prensadas en seco. Características de calidad según las Normas EN 14411-ISO 13006 Apéndice G grupo Bia UGL.	PRESCRIZIONE STANDARD REQUIREMENTS PRESCRIPTIONS ANFORDERUNGEN PRESCRIPCION		RISULTATI TESTS TEST RESULTS RESULTATS DES ESSAIS PRÜFERGEBNIS RESULTADOS TESTS				RIFERIMENTO NORMA REFERENCE STANDARD RÉFÉRENCE NORME STANDARWORT REFERENCIA NORMA	
		N ≥ 15 cm		CRAYONS	MATCH-UP		WOODSLATE LIFE		
		(%)	(mm)	naturale	comfort	lucido	naturale		
	LUNGHEZZA E LARGHEZZA: DEVIAZIONE AMMISSIBILE IN %, DELLA DIMENSIONE MEDIA DI OGNI PIASTRELLA DALLA DIM. DI FABBRICAZIONE / LENGTH AND WIDTH: ADMITTED DEVIATION, IN %, OF THE AVERAGE SIZE OF EACH TILE FROM THE PRODUCTION DIMENSIONS / LONGUEUR ET LARGEUR: MARGE DE TOLÉRANCE, EN %, ENTRE LA DIMENSION MOYENNE DE CHAQUE CARREAU ET LA DIM. DE FABRICATION / LANGE UND BREITE: ZULÄSSIGE ABWEICHUNG DES DURCHSCHNITTSMAßES JEDER FLIESE VOM HERSTELLMAß IN PROZENTEN / LARGO Y ANCHO: DESVIACION ADMISIBLE, EN %, DEL TAMAÑO MEDIO DE CADA BALDOSA A PARTIR DEL TAMAÑO DE FABRICACION.	Squadrato ISO 13006	±0,3%	±1,0mm		±0,15%		ISO 10545-2	
	DEVIAZIONE AMMISSIBILE, IN PERCENTO, DELLO SPESORE MEDIO DI OGNI PIASTRELLA DALLA DIMENSIONE DI FABBRICAZIONE / ADMITTED DEVIATION, IN %, OF THE AVERAGE THICKNESS OF EACH TILE FROM THE PRODUCTION DIMENSIONS / MARGE DE TOLÉRANCE, EN POURCENTAGE, ENTRE L'ÉPAISSEUR MOYENNE DE CHAQUE CARREAU ET LA DIMENSION DE FABRICATION / ZULÄSSIGE ABWEICHUNG DER DURCHSCHNITTSDICKE JEDER FLIESE VOM HERSTELLMAß IN PROZENTEN / DESVIACION ADMISIBLE, EN TANTO POR CIENTO, DEL GROSOR MEDIO DE CADA BALDOSA A PARTIR DEL TAMAÑO DE FABRICACION.	-	±5%	±0,5mm		±5%		ISO 10545-2	
	DEVIAZIONE MASSIMA DI RETTILINEARITÀ, IN PERCENTO, IN RAPPORTO ALLE DIMENSIONI DI FABBRICAZIONE CORRISPONDENTI / MAXIMUM STRAIGHTNESS DEVIATION, IN %, IN RELATION TO THE CORRESPONDING PRODUCTION DIMENSIONS / MARGE DE TOLÉRANCE, EN POURCENTAGE, PAR RAPPORT A LA DIMENSION CORRÉPONDANTE / ZULÄSSIGE HOCHSTABWEICHUNG DER KANTENGERADHEIT IM VERHÄLTNIß ZU DEN ENTSPRECHENDEN HERSTELLMAßEN IN PROZENTEN / DESVIACION MÁXIMA DE RECTITUD, EN TANTO POR CIENTO, EN RELACION CON EL TAMAÑO DE FABRICACION CORRESPONDIENTE.	Squadrato ISO 13006	±0,3%	±0,8mm		±0,10%		ISO 10545-2	
	DEVIAZIONE MASSIMA DI ORTOGONALITÀ, IN PERCENTO, IN RAPPORTO ALLE DIMENSIONI DI FABBRICAZIONE CORRISPONDENTI MAXIMUM RIGHT-ANGLE DEVIATION, IN %, IN RELATION TO THE CORRESPONDING PRODUCTION DIMENSIONS / MARGE DE TOLÉRANCE, EN POURCENTAGE, PAR RAPPORT A LA DIMENSION CORRÉPONDANTE / HOCHSTABWEICHUNG DER RECHTWINKLIGKEIT IM VERHÄLTNIß ZU DEN ENTSPRECHENDEN HERSTELLMAßEN IN PROZENTEN / DESVIACION MÁXIMA DE LA ORTOGONALIDAD, EN TANTO POR CIENTO, EN RELACION CON EL TAMAÑO DE FABRICACION CORRESPONDIENTE.	Squadrato ISO 13006	±0,3%	±1,5mm		±0,20%		ISO 10545-2	
	PLANARITÀ (CURVATURA DEL CENTRO, DELLO SPIGOLO E SVERGOLAMENTO) / FLATNESS (CURVING IN THE MIDDLE, CORNER AND WARPING) / PLANEITÉ (COURBURE CENTRALE, DE L'ARÊTE ET GAUCHISSEMENT) / EBENFLÄCHIGKEIT (KRÜMMUNG DER MITTE, DER KANTE UND VERWINDUNG) / PLANITUD (CURVATURA DEL CENTRO, DE LA ARTISA Y ABAQUILLAMIENTO).	Squadrato ISO 13006	±0,4%	±1,8mm		±0,20%		ISO 10545-2	
	QUALITÀ DELLA SUPERFICIE / SURFACE QUALITY / QUALITÉ DE LA SURFACE / QUALITÄT DER OBERFLÄCHE / CALIDAD DE LA SUPERFICIE.					CONFORME/CONFORMING CONFORME/KONFORM CONFORME		ISO 10545-2	
	MASSA D'ACQUA ASSORBITA IN % / % WATER ABSORPTION - MASSES D'EAU ABSORBÉE EN % / WASSERAUFNAHME IN % / MASA DE AGUA ABSORBIDA EN %		< 0,5%			valore medio 0,08%		ISO 10545-3	
	FORZA DI ROTTURA IN N (sp. < 7,5 mm) - BREAKING STRENGTH IN N (thickness < 7,5 mm) / FORCE DE RUPTURE EN N (ép. < 7,5 mm) / BRUCHLAST IN N (Dicke < 7,5 mm) / FUERZA DE ROTURA EN N (gr. < 7,5 mm).		≥ 700			valore medio 1350 Newton		ISO 10545-4	
	RESISTENZA ALLA FLESSIONE IN N/mm ² / N/mm ² FLEXURAL STRENGTH TEST / RESISTANCE A LA FLEXION EN N/mm ² / BIEGEFESTIGKEIT IN N/mm ² / RESISTENCIA A LA FLEXION EN N/mm ²		35 MIN.			valore medio 52 N/mm ²		ISO 10545-4	
	RESISTENZA ALL'ABRASIONE PROFONDA DELLE PIASTRELLE NON SMALTATE / RESISTANCE TO DEEP ABRASION OF UNGLAZED TILES / RESISTANCE A L'ABRASION PROFONDE DES CARREAUX NON ÉMAILLÉS / TIEFENABRIEBFESTIGKEIT UNGLASIRTER FLIESEN / RESISTENCIA A LA ABRASION PROFUNDA DE LAS BALDOSAS SIN ESMALTAR.		< 175 mm ³			valore medio 140 mm ³		ISO 10545-6	
	RESISTENZA AGLI SBALZI TERMICI / THERMAL SHOCKS RESISTANT / RESISTANCE AUX VARIATIONS THERMIQUES / TEMPERATURWECHSELBESTÄNDIGKEIT / RESISTENCIA AL CHOQUE TÉRMICO.	Metodo di prova disponibile / Available testing method Méthode d'essai disponible / Verfügbare Prüfmethode Método de ensayo disponible				RESISTE - RESISTANT RESISTE - ERFÜLLT RESISTE		ISO 10545-9	
	RESISTENZA AL GELO / FROST RESISTANCE / RESISTANCE AU GEL / FROSTSICHERHEIT RESISTENCIA A LA HELADA	RICHIESTA - REQUIRED REQUIRE - GEFORDERT REQUERIDA				RESISTE - RESISTANT RESISTE - ERFÜLLT RESISTE		ISO 10545-12	
	RESISTENZA ALLE MACCHIE / RESISTANCE TO STAINING / RESISTANCE AUX TACHES / FLECKENABWEISEND / RESISTENCIA A LAS MANCHAS.	Metodo di prova disponibile / Available testing method Méthode d'essai disponible / Verfügbare Prüfmethode Método de ensayo disponible			Classe 5	Classe 5	Classe 4-5	Classe 4-5	ISO 10545-14
	RILASCIO DI SOSTANZE PERICOLOSE / RELEASE OF HAZARDOUS SUBSTANCES / REJET DE SUBSTANCES DANGEREUSES / FREISETZUNG GEFÄHRLICHER STOFFE / LIBERACION DE SUSTANCIAS PELIGROSAS / CADMIO (in mg/dm ²) - PIOMBO (in mg/dm ²)	VALORE DICHIARATO PER SUPERFICI GL. CON IMPREGH SU PIANI DI LAVORO / DECLARED VALUE FOR GL SURFACES USED ON WORKTOPS / VALEUR DÉCLARÉE POUR SURFACES GL UTILISÉES SUR PLANS DE TRAVAIL / ANGEBOBENER WERT FÜR GL OBERFLÄCHEN ZUM GEBRAUCH ALS ARBEITSPLETTEN / VALOR DECLARADO PARA ACABADOS GL UTILIZADOS PARA SUPERFICIES DE TRABAJO				CONFORME/CONFORMING CONFORME/KONFORM CONFORME		DM-1-2-2007-Reg-CE-1935-2004	
	RESISTENZA A BASSE CONCENTRAZIONI DI ACIDI E ALCALI. / RESISTANCE TO LOW CONCENTRATIONS OF ACIDS AND ALKALIS. / RESISTANCE A BASSES CONCENTRATIONS D'ACIDES ET ALCALIS. / WIDERSTAND GEGEN NIEDRIGE KONZENTRATIONEN VON SAUREN UND LAUGEN. / RESISTENCIA A BAJAS CONCENTRACIONES DE ACIDOS Y ALCALIS.	COME DICHIARATO DAL PRODUTTORE SEE MANUFACTURER'S DECLARATION SELON DÉCLARATION DU PRODUCTEUR ENTSPRECHEND DER HERSTELLERANGABEN TAL COMO DECLARA EL FABRICANTE	MIN B		ULA-ULB	ULA	ULA-ULB	ULA	ISO 10545-13
	RESISTENZA AI PRODOTTI CHIMICI DI USO DOMESTICO E AGLI ADDITIVI PER PISCINA / RESISTENCE TO DOMESTIC CHEMICAL PRODUCTS AND ADDITIVES FOR SWIMMING POOLS / RESISTANT AUX PRODUITS CHIMIQUES À USAGE DOMESTIQUE ET AUX ADDITIFS POUR PISCINE / WIDERSTAND GEGEN HAUSHALTSHEMIELEMITTEL UND SCHWIMMBADZUSATZSTOFFEN / RESISTENCIA A PRODUCTOS PARA LIMPIEZA DOMESTICA Y ADITIVOS PARA PISCINAS					UA			
					6° ≤ α < 10° R9	10° ≤ α < 19° R10		10° ≤ α < 19° R10	DIN EN 16165 ANNEX B
	COEFFICIENTE D'ATTRITO (SCIVOLITÀ) / FRICTION COEFFICIENT (SLIPPERINESS) / COEFFICIENT DE FRICTION (GLISSEMENT) / REIBUNGSKOEFFIZIENT (SCHLUPFRIGKEIT) / COEFFICIENTE DE ANTI DESLIZAMIENTO.					18° ≤ α < 24° classe B		18° ≤ α < 24° classe B	DIN EN 16165 ANNEX A
						PTV > 36 wet slider 4S			BS EN 16165 ANNEX C
						DCOF > 0,42 wet		DCOF > 0,42 wet	ANSI A 326.3

Per un effetto ottimale della posa, florim suggerisce di mantenere 2 mm di fuga per pose monofornate e 3 mm per combinare formati misti / For optimal installation results, florim recommends maintaining a joint of 2 mm 1/16" for single format installations and 3 mm 1/8" to combine mixed formats / Pour réaliser une pose parfaite, florim suggère de maintenir 2 mm de joint pour la pose des monofornats, et 3 mm pour les combinaisons de formats mixtes / Um einen optimalen effekt beim verlegen zu erzielen empfiehlt florim eine 2 mm fuge bei einformatigen verlegungen und 3 mm fuge bei formatkombinationen / Para lograr los máximos resultados en la posa del producto, florim aconseja 2 mm de junta en aplicaciones monofornato y 3 mm en combinaciones de formatos mixtos.



CARATTERISTICHE TECNICHE

TECHNICAL FEATURES
CARACTÉRISTIQUES TECHNIQUES
TECHNISCHE EIGENSCHAFTEN
CARACTERÍSTICAS TÉCNICAS











9mm



CARATTERISTICHE TECNICHE - TECHNICAL CHARACTERISTICS - CARACTERISTIQUES TECHNIQUES - TECHNISCHE EIGENSCHAFTEN - CARACTERÍSTICAS TÉCNICAS						
	PIASTRELLA DI CERAMICA PRESSED A SECCO. CARATTERISTICHE DI QUALITÀ SECONDO I TEST DI CONTROLLO PREVISTI DALLA NORMA EN 14411-ISO 13006 APPENDICE G GRUPPO BIA GL / DRY-PRESSED CERAMIC TILES. QUALITY SPECIFICATIONS, ACCORDING TO CONTROL TESTS OF EN 14411-ISO 13006 APPENDIX G GROUP BIA GL / CARREAUX CÉRAMIQUES PRESSÉS À SEC. CARACTÉRISTIQUES DE QUALITÉ D'APRÈS LES ESSAIS DE CONTRÔLE NORME EN 14411-ISO 13006 APPENDICE G GROUPE BIA GL. / TROCKEN GEPRESSTE KERAMIKFLIESEN. / QUALITÄTSEIGENSCHAFTEN NACH NORMEN EN 14411-ISO 13006 ANHANG G GRUPPE BIA GL. / BALDOSAS DE CERÁMICA RENSADAS EN SECO. CARACTERÍSTICAS DE CALIDAD SEGÚN LAS NORMAS EN 14411-ISO 13006 APÉNDICE G GRUPO BIA GL.	PRESCRIZIONE STANDARD REQUIREMENTS PRESCRIPTIONS ANFORDERUNGEN PRESCRIPCION		RISULTATI TESTS TEST RESULTS RESULTATS DES ESSAIS PRÜFERGEBNIS RESULTADOS TESTS	RIFERIMENTO NORMA REFERENCE STANDARD RÉFÉRENCE NORME STANDARDWERT REFERENCIA NORMA	
		N ≥ 15 cm				
		(%)	(mm)			
	LUNGHEZZA E LARGHEZZA: DEVIAZIONE AMMISSIBILE, IN %, DELLA DIMENSIONE MEDIA DI OGNI PIASTRELLA DALLA DIM. DI FABBRICAZIONE / LENGTH AND WIDTH: ADMITTED DEVIATION, IN %, OF THE AVERAGE SIZE OF EACH TILE FROM THE PRODUCTION DIMENSIONS / LONGUEUR ET LARGEUR: MARGE DE TOLÉRANCE, EN %, ENTRE LA DIMENSION MOYENNE DE CHAQUE CARREAU ET LA DIM. DE FABRICATION / LÄNGE UND BREITE: ZULÄSSIGE ABWEICHUNG DES DURCHSCHNITTMÄßES JEDER FLIESE VOM HERSTELLMAß IN PROZENTEN / LARGO Y ANCHO: DESVIACIÓN ADMISIBLE, EN %, DEL TAMAÑO MEDIO DE CADA BALDOSA A PARTIR DEL TAMAÑO DE FABRICACIÓN	Squadrato ISO 13006	±0,3%	±1,0mm	±0,15%	ISO 10545-2
	DEVIAZIONE AMMISSIBILE, IN PERCENTO, DELLO SPESSORE MEDIO DI OGNI PIASTRELLA DALLA DIMENSIONE DI FABBRICAZIONE / ADMITTED DEVIATION, IN %, OF THE AVERAGE THICKNESS OF EACH TILE FROM THE PRODUCTION DIMENSIONS / MARGE DE TOLÉRANCE, EN POURCENTAGE, ENTRE L'ÉPAISSEUR MOYENNE DE CHAQUE CARREAU ET LA DIMENSION DE FABRICATION / ZULÄSSIGE ABWEICHUNG DER DURCHSCHNITTSDICKE JEDER FLIESE VOM HERSTELLMAß IN PROZENTEN / DESVIACIÓN ADMISIBLE, EN TANTO POR CIENTO, DEL GROSOR MEDIO DE CADA BALDOSA A PARTIR DEL TAMAÑO DE FABRICACIÓN	-	±5%	±0,5mm	±5%	
	DEVIAZIONE MASSIMA DI RETTILINEARITÀ, IN PERCENTO, IN RAPPORTO ALLE DIMENSIONI DI FABBRICAZIONE CORRISPONDENTI / MAXIMUM STRAIGHTNESS DEVIATION, IN %, IN RELATION TO THE CORRESPONDING PRODUCTION DIMENSIONS / MARGE DE TOLÉRANCE DE RECTITUDE, EN POURCENTAGE, PAR RAPPORT AUX DIMENSIONS DE FABRICATION CORRESPONDANTES / ZULÄSSIGE HOCHSTABWEICHUNG DER KANTENGERADHEIT IM VERHÄLTNIS ZU DEN ENTSPRECHENDEN HERSTELLMAßEN IN PROZENTEN / DESVIACIÓN MÁXIMA DE RECTITUD, EN TANTO POR CIENTO, EN RELACIÓN CON EL TAMAÑO DE FABRICACIÓN CORRESPONDIENTE	Squadrato ISO 13006	±0,3%	±0,8mm	±0,10%	
	DEVIAZIONE MASSIMA DI ORTOGONALITÀ, IN PERCENTO, IN RAPPORTO ALLE DIMENSIONI DI FABBRICAZIONE CORRISPONDENTI MAXIMUM RIGHT-ANGLE DEVIATION, IN %, IN RELATION TO THE CORRESPONDING PRODUCTION DIMENSIONS / MARGE DE TOLÉRANCE D'ANGULARITÉ, EN POURCENTAGE, PAR RAPPORT AUX DIMENSIONS DE FABRICATION / HOCHSTABWEICHUNG DER RECHTWINKLIGKEIT IM VERHÄLTNIS ZU DEN ENTSPRECHENDEN HERSTELLMAßEN IN PROZENTEN / DESVIACIÓN MÁXIMA DE LA ORTOGONALIDAD, EN TANTO POR CIENTO, EN RELACIÓN CON EL TAMAÑO DE FABRICACIÓN CORRESPONDIENTE	Squadrato ISO 13006	±0,3%	±1,5mm	±0,2%	
	PLANARITÀ (CURVATURA DEL CENTRO, DELLO SPIGOLO E SVERGOLAMENTO) / FLATNESS (CURVING IN THE MIDDLE, CORNER AND WARPING) / PLANÉTÉ (COURBURE CENTRALE, DE L'ARÊTE ET GAUCHISSEMENT) / EBENFLÄCHIGKEIT (KRÜMMUNG DER MITTE, DER KANTE UND VERWINDUNG) / PLANITUD (CURVATURA DEL CENTRO, DE LA ARISTA Y ABARQUILLAMIENTO)	Squadrato ISO 13006	±0,4%	±1,8mm	±0,35%	
	QUALITÀ DELLA SUPERFICIE - SURFACE QUALITY / QUALITÉ DE LA SURFACE - QUALITÄT DER OBERFLÄCHE / CALIDAD DE LA SUPERFICIE	Il 95% min delle piastrelle deve essere esente da difetti visibili. / At least 95% of the tiles must be free from visible flaws. / 95% min des carreaux ne doivent présenter aucun défaut visible. Mindestens 95% der Fliesen müssen frei von sichtbaren min. / el 95% de las baldosas tiene que estar exento de defectos visibles.		CONFORME/CONFORMING CONFORME/KONFORM CONFORME		
	MASSA D'ACQUA ASSORBITA IN % / % WATER ABSORPTION - MASSE DEAU ABSORBÉE EN % / WASSERAUFNAHME IN % MASA DE AGUA ABSORBIDA EN %		E≤0,5%		valore medio 0,08 %	ISO 10545-3
	FORZA DI ROTTURA IN N (sp. ≥ 7,5 mm) - BREAKING STRENGTH IN N (thickness ≥ 7,5 mm) / FORCE DE RUPTURE EN N (ép. ≥ 7,5 mm) / BRUCHLAST IN N (Dicke ≥ 7,5 mm) / FUERZA DE ROTTURA EN N (gr. ≥ 7,5 mm)		1300 min		valore medio 2200 Newton	ISO 10545-4
	RESISTENZA ALLA FLESSIONE IN N/mm2 / N/mm2 FLEXURAL STRENGTH TEST / RÉSISTANCE A LA FLEXION EN N/mm2 / BIEGEFESTIGKEIT IN N/mm2 / RESISTENCIA A LA FLEXIÓN EN N/mm2		35 min		valore medio 50 N/mm2	ISO 10545-4
	RESISTENZA ALL'ABRASIONE DELLE PIASTRELLE SMALTATE / RESISTANCE TO ABRASION OF GLAZED TILES / RESISTANCE A L'ABRASION DES CARREAUX ÉMAILLÉS / TIEFENABRIEBFESTIGKEIT GLASIERTER FLIESEN / RESISTENCIA A LA ABRASIÓN DE LAS BALDOSAS ESMALTADAS	COME DICHIARATO DAL PRODUTTORE SEE MANUFACTURERS DECLARATION SELON DECLARATION DU PRODUCTEUR ENTSPRECHEND DER HERSTELLERANGABEN TAL COMO DECLARA EL FABRICANTE		vedere la serie - see the collection voir la collection - siehe der kollektion ver la coleccion		ISO 10545-7
	RESISTENZA AGLI SBALZI TERMICI / THERMAL SHOCKS RESISTANT / RÉSISTANCE AUX VARIATIONS THERMIQUES / TEMPERATURWECHSELBESTÄNDIGKEIT / RESISTENCIA AL CHOQUE TÉRMICO		-		RESISTE - RÉSISTANT RÉSISTE - ERFÜLLT - RESISTE	ISO 10545-9
	RESISTENZA ALLE MACCHIE / RESISTANCE TO STAINING / RÉSISTANCE AUX TACHES / FLECKENABWEISEND / RESISTENCIA A LAS MANCHAS		Classe 3 min		≥ Classe 3	ISO 10545-14
	RESISTENZA A BASSE CONCENTRAZIONI DI ACIDI E ALCALI. / RESISTANCE TO LOW CONCENTRATIONS OF ACIDS AND ALKALIS. / RESISTANCE A BASSES CONCENTRATIONS D'ACIDES ET ALCALIS. / WIDERSTAND GEGEN NIEDRIGE KONZENTRATIONEN VON SAUREN UND LAUGEN. / RESISTENCIA A BAJAS CONCENTRACIONES DE ACIDOS Y ALCALIS.	COME DICHIARATO DAL PRODUTTORE SEE MANUFACTURERS DECLARATION SELON DECLARATION DU PRODUCTEUR ENTSPRECHEND DER HERSTELLERANGABEN TAL COMO DECLARA EL FABRICANTE		vedere la serie - see the collection voir la collection - siehe der kollektion ver la coleccion		ISO 10545-13
	RESISTENZA AI PRODOTTI CHIMICI DI USO DOMESTICO E AGLI ADDITIVI PER PISCINA / RESISTENCE TO DOMESTIC CHEMICAL PRODUCTS AND ADDITIVES FOR SWIMMING POOLS / RÉSISTANT AUX PRODUITS CHIMIQUES À USAGE DOMESTIQUE ET AUX ADDITIFS POUR PISCINE / WIDERSTAND GEGEN HAUSHALTSCHEMIKALIEN UND SCHWIMMBADZUSATZSTOFFEN / RESISTENCIA A PRODUCTOS PARA LIMPIEZA DOMÉSTICA Y ADITIVOS PARA PISCINAS		GB min		GA	
	RESISTENZA AL GELO / FROST RESISTANCE - RÉSISTANCE AU GEL / FROSTSICHERHEIT - RESISTENCIA A LA HELADA		RICHIESTA / REQUIRED REQUISE / GEFORDET REQUERIDA		RESISTE - RÉSISTANT RÉSISTE - ERFÜLLT RESISTE	ISO 10545-12
	RESISTENZA AL CAVILLO DI PIASTRELLE SMALTATE / GLAZE CRAZING RESISTANCE - RÉSISTANCE AU TRESSAILLAGE POUR LES CARREAUX ÉMAILLÉS / WIDERSTAND GEGEN HAARRISS VON GLASIERTEN FLIESEN - RESISTENCIA AL CUARTEADO DE LOS AZULEJOS ESMALTADOS		RICHIESTA / REQUIRED REQUISE / GEFORDET REQUERIDA		RESISTE - RÉSISTANT RÉSISTE - ERFÜLLT RESISTE	ISO 10545-11
	COEFFICIENTE D'ATTRITO (SCIVOLOSITÀ) / FRICTION COEFFICIENT (SLIPPERINESS) / COEFFICIENT DE FRICTION (GLISSEMENT) / REIBUNGSKOEFFIZIENT (SCHLÜPFRIEGKEIT) - COEFICIENTE DE ANTI DESLIZAMIENTO		-		vedere la serie - see the collection voir la collection - siehe der kollektion ver la coleccion	-

Per un effetto ottimale della posa, florim suggerisce di mantenere 2 mm di fuga per pose monoformato e 3 mm per combinare formati misti / For optimal installation results, florim recommends maintaining a joint of 2 mm 1/12" for single format installations and 3 mm 1/8" to combine mixed formats / Pour réaliser une pose parfaite, florim suggère de maintenir 2 mm de joint pour la pose des monoformats, et 3 mm pour les combinaisons de formats mixtes / Um einen optimalen effekt beim verlegen zu erzielen empfiehlt florim eine 2 mm fuge bei einformatigen verlegungen und 3 mm fuge bei formatkombinationen / Para lograr los máximos resultados en la posa del producto, florim aconseja 2 mm de junta en aplicaciones monoformato y 3 mm en combinaciones de formatos mixtos

Per informazioni relative ai dati tecnici su marcatura CE vedere il sito www.florim.com - Please refer to our web site www.florim.com for technical information related to CE labeling - Pour tout renseignement sur l'avis technique de la marque CE veuillez consulter le site www.florim.com - Informationen bezüglich technischer Daten zur Beschriftung CE entnehmen Sie unserer Website www.florim.com - For informaciones sobre datos técnicos sobre marca CE mirar al sito www.florim.com

CARATTERISTICHE TECNICHE - TECHNICAL CHARACTERISTICS - CARACTERISTIQUES TECHNIQUES - TECHNISCHE EIGENSCHAFTEN - CARACTERÍSTICAS TÉCNICAS						
		PRESCRIZIONE STANDARD REQUIREMENTS PRESCRIPTIONS ANFORDERUNGEN PRESCRIPCION	RISULTATI TESTS TEST RESULTS RESULTATS DES ESSAIS PRÜFERGEBNIS RESULTADOS TESTS	RIFERIMENTO NORMA REFERENCE STANDARD RÉFÉRENCE NORME STANDARDWERT REFERENCIA NORMA		
					N > 15 cm (%) (mm)	
	Lastrre in gres fine porcellanato non smaltato. Piastrelle di ceramica pressate a secco. Caratteristiche di qualità secondo i test di controllo previsti dalla norma EN 14411-ISO 13006 Appendix G gruppo Bia UGL/ Unglazed porcelain stoneware slabs. Dry-pressed ceramic tiles. Quality specifications, according to control tests of EN 14411-ISO 13006 Appendix G group Bia UGL. / Dalles en gres cérame fin non émaillé. Carreaux céramiques pressés à sec. Caractéristiques de qualité d'après les essais de contrôle norme EN 14411-ISO 13006 Appendix G groupe Bia UGL/ Nicht glasierte und vollständig gesinterte Feinsteinzeugplatten. Trocken gepresste Keramikfliesen. Qualitätseigenschaften nach Normen EN 14411-ISO 13006 Anhang G Gruppe Bia UGL/ Planchas de gres porcelánico fino no esmaltado. Baldosas de cerámica resadas en seco. Características de calidad según las Normas EN 14411-ISO 13006 Apéndice G grupo B1a UGL.					
	LUNGHEZZA E LARGHEZZA: DEVIAZIONE AMMISSIBILE, IN %, DELLA DIMENSIONE MEDIA DI OGNI PIASTRELLA DALLA DIM. DI FABBRICAZIONE / LENGTH AND WIDTH: ADMITTED DEVIATION, IN %, OF THE AVERAGE SIZE OF EACH TILE FROM THE PRODUCTION DIMENSIONS / LONGUEUR ET LARGEUR : MARGE DE TOLERANCE, EN %, ENTRE LA DIMENSION MOYENNE DE CHAQUE CARREAU ET LA DIM. DE FABRICATION / LANGE UND BREITE: ZULASSIGE ABWEICHUNG DES DURCHSCHNITTMÄßES JEDER FLIESE VOM HERSTELLMÄß IN PROZENTEN / LARGO Y ANCHO: DESVIACION ADMISIBLE, EN %, DEL TAMAÑO MEDIO DE CADA BALDOSA A PARTIR DEL TAMAÑO DE FABRICACION.	Squadrato ISO 13006	±0,3%	±1,0mm	±0,15%	
	DEVIAZIONE AMMISSIBILE, IN PERCENTO, DELLO SPESORE MEDIO DI OGNI PIASTRELLA DALLA DIMENSIONE DI FABBRICAZIONE / ADMITTED DEVIATION, IN %, OF THE AVERAGE THICKNESS OF EACH TILE FROM THE PRODUCTION DIMENSIONS / MARGE DE TOLERANCE, EN POURCENTAGE, ENTRE L'ÉPAISSEUR MOYENNE DE CHAQUE CARREAU ET LA DIMENSION DE FABRICATION / ZULASSIGE HOCHSTABWEICHUNG DER DURCHSCHNITTSDicKE JEDER FLIESE VOM HERSTELLMÄß IN PROZENTEN / DESVIACION ADMISIBLE, EN TANTO POR CIENTO, DEL GROSOR MEDIO DE CADA BALDOSA A PARTIR DEL TAMAÑO DE FABRICACION.	-	±5%	±0,5mm	±5%	
	DEVIAZIONE MASSIMA DI RETTILINEARITÀ, IN PERCENTO, IN RAPPORTO ALLE DIMENSIONI DI FABBRICAZIONE CORRISPONDENTI / MAXIMUM STRAIGHTNESS DEVIATION, IN %, IN RELATION TO THE CORRESPONDING PRODUCTION DIMENSIONS / MARGE DE TOLERANCE DE RECTITUDE, EN POURCENTAGE, PAR RAPPORT AUX DIMENSIONS DE FABRICATION CORRESPONDANTES / ZULASSIGE HOCHSTABWEICHUNG DER KANTENGERADHEIT IM VERHÄLTNIS ZU DEN ENTSPRECHENDEN HERSTELLMÄßEN IN PROZENTEN / DESVIACION MÁXIMA DE RECTITUD, EN TANTO POR CIENTO, EN RELACION CON EL TAMAÑO DE FABRICACION CORRESPONDIENTE.	Squadrato ISO 13006	±0,3%	±0,8mm	±0,10%	
	DEVIAZIONE MASSIMA DI ORTOGONALITÀ, IN PERCENTO, IN RAPPORTO ALLE DIMENSIONI DI FABBRICAZIONE CORRISPONDENTI / MAXIMUM RIGHT-ANGLE DEVIATION, IN %, IN RELATION TO THE CORRESPONDING PRODUCTION DIMENSIONS / MARGE DE TOLERANCE D'ANGULARITÉ, EN POURCENTAGE, PAR RAPPORT AUX DIMENSIONS DE FABRICATION / HOCHSTABWEICHUNG DER RECHTWINKLIGKEIT IM VERHÄLTNIS ZU DEN ENTSPRECHENDEN HERSTELLMÄßEN IN PROZENTEN / DESVIACION MÁXIMA DE LA ORTOGONALIDAD, EN TANTO POR CIENTO, EN RELACION CON EL TAMAÑO DE FABRICACION CORRESPONDIENTE.	Squadrato ISO 13006	±0,3%	±1,5mm	±0,2%	
	PLANARITÀ (CURVATURA DEL CENTRO, DELLO SPIGOLO E SVERGOLAMENTO) / FLATNESS (CURVING IN THE MIDDLE, CORNER AND WARPING) / PLANÉITÉ (COURBURE CENTRALE, DE L'ARÊTE ET GAUCHISSEMENT) / EBENFLÄCHIGKEIT (KRÜMMUNG DER MITTE, DER KANTE UND VERWINDUNG) / PLANITUD (CURVATURA DEL CENTRO, DE LA ARISTA Y ABARQUILLAMIENTO).	Squadrato ISO 13006	±0,4%	±1,8 mm	±0,35%	
	QUALITÀ DELLA SUPERFICIE - SURFACE QUALITY / QUALITÉ DE LA SURFACE - QUALITÄT DER OBERFLÄCHE / CALIDAD DE LA SUPERFICIE.				Il 95% min delle piastrelle deve essere esente da difetti visibili. / At least 95% of the tiles must be free from visible flaws. 95% min des carreaux ne doivent présenter aucun défaut visible. / Mindestens 95% der Fliesen müssen frei von sichtbaren min. / el 95% de las baldosas tiene que estar exento de defectos visibles.	CONFORME/CONFORMING CONFORME/KONFORM CONFORME.
	MASSA D'ACQUA ASSORBITA IN % / % WATER ABSORPTION - MASSE D'EAU ABSORBÉE EN % / WASSERAUFNAHME IN % MASA DE AGUA ABSORBIDA EN %		Es0,5%		valore medio 0,08%	ISO 10545-3
	FORZA DI ROTTURA IN N (sp. ≥ 7,5 mm) - BREAKING STRENGTH IN N (thickness ≥ 7,5 mm) / FORCE DE RUPTURE EN N (ép. ≥ 7,5 mm) / BRUCHLAST IN N (Dicke ≥ 7,5 mm) / FUERZA DE ROTURA EN N (gr. ≥ 7,5 mm)		1300 min		valore medio 2200 N (9mm) valore medio 14000 N (20mm)	ISO 10545-4
	RESISTENZA ALLA FLESSIONE IN N/mm ² / N/mm ² FLEXURAL STRENGTH TEST / RÉSISTANCE A LA FLEXION EN N/mm ² / BIEGEFESTIGKEIT IN N/mm ² / RESISTENCIA A LA FLEXION EN N/mm ²		35 min		valore medio 50 N/mm ² (9mm) valore medio 52 N/mm ² (20mm)	ISO 10545-4
	RESISTENZA ALL'ABRASIONE PROFONDA DELLE PIASTRELLE NON SMALTATE / RESISTANCE TO DEEP ABRASION OF UNGLAZED TILES / RESISTANCE À L'ABRASION PROFONDE DES CARREAUX NON ÉMAILLÉS / TIEFENABRIEGE-STEIGKEIT UNGLASIERTER FLIESEN / RESISTENCIA A LA ABRASION PROFUNDA DE LAS BALDOSAS SIN ESMALTAR		<175mm ³		valore medio 140mm ³	ISO 10545-6
	RESISTENZA AGLI SBALZI TERMICI / THERMAL SHOCKS RESISTANT / RÉSISTANCE AUX VARIATIONS THERMIQUES TEMPÉRATURWECHSELBESTÄNDIGKEIT / RESISTENCIA AL CHOQUE TÉRMICO.		-		RESISTE - RÉSISTANT RÉSISTE - ERFÜLLT RÉSISTE	ISO 10545-9
	RESISTENZA ALLE MACCHIE / RESISTANCE TO STAINING / RÉSISTANCE AUX TACHES / FLECKENABWEISEND RESISTENCIA A LAS MANCHAS		-		≥ Classe 3	ISO 10545-14
	RESISTENZA A BASSE CONCENTRAZIONI DI ACIDI E ALCALI. / RESISTANCE TO LOW CONCENTRATIONS OF ACIDS AND ALKALIS. / RESISTANCE A BASSES CONCENTRATIONS D'ACIDES ET ALCALIS. / WIDERSTAND GEGEN NIEDRIGE KONZENTRATIONEN VON SAUREN UND LAUGEN. / RESISTENCIA A BAJAS CONCENTRACIONES DE ACIDOS Y ALCALIS.				vedere la serie - see the collection voir la collection - siehe der kollektion ver la coleccion	
	RESISTENZA A ALTE CONCENTRAZIONI DI ACIDI ED ALCALI / RESISTANCE TO HIGH CONCENTRATIONS OF ACIDS AND ALKALIS / RESISTANCE À HAUTES CONCENTRATIONS D'ACIDES ET BASES / BESTÄNDIGKEIT GEGEN STARK KONZENTRIERTE SAUREN UND LAUGEN / RESISTENCIA A ALTAS CONCENTRACIONES DE ACIDOS Y ALCALIS					ISO 10545-13
	RESISTENZA AI PRODOTTI CHIMICI DI USO DOMESTICO E AGLI ADDITIVI PER PISCINA / RESISTENCE TO DOMESTIC CHEMICAL PRODUCTS AND ADDITIVES FOR SWIMMING POOLS / RÉSISTANT AUX PRODUITS CHIMIQUES À USAGE DOMESTIQUE ET AUX ADDITIFS POUR PISCINE / WIDERSTAND GEGEN HAUSHALTS-CHEMIKALIEN UND SCHWIMMBADZUSATZSTOFFEN / RESISTENCIA A PRODUCTOS PARA LIMPIEZA DOMESTICA Y ADITIVOS PARA PISCINAS		UB min		UA	
	RESISTENZA AL GELO / FROST RESISTANCE - RÉSISTANCE AU GEL / FROSTSICHERHEIT - RESISTENCIA A LA HELADA		RICHIESTA / REQUIRED REQUISE / GEFORDERT REQUERIDA		RESISTE - RÉSISTANT RÉSISTE - ERFÜLLT RÉSISTE	ISO 10545-12
	COEFFICIENTE D'ATTRITO (SCIVOLOSITÀ) / FRICTION COEFFICIENT (SLIPPERINESS) / COEFFICIENT DE FRICTION (GLISSÉMENT) / REIBUNGSKOEFFIZIENT (SCHLUPFRIGKEIT) - COEFICIENTE DE ANTI DESLIZAMIENTO		-		vedere la serie - see the collection voir la collection - siehe der kollektion ver la coleccion	-

Per un effetto ottimale della posa, florim suggerisce di mantenere 2 mm di fuga per pose monoformato e 3 mm per combinare formati misti / For optimal installation results, florim recommends maintaining a joint of 2 mm 1/12" for single format installations and 3 mm 1/8" to combine mixed formats / Pour réaliser une pose parfaite, florim suggère de maintenir 2 mm de joint pour la pose des monoformats, et 3 mm pour les combinaisons de formats mixtes / Um einen optimalen effekt beim verlegen zu erzielen empfiehlt florim eine 2 mm fuge bei einformatigen verlegungen und 3 mm fuge bei formatkombinationen / Para lograr los máximos resultados en la posa del producto, florim aconseja 2 mm de junta en aplicaciones monoformato y 3 mm en combinaciones de formatos mixtos.

Per informazioni relative ai dati tecnici su marcatra CE vedere il sito www.florim.com - Please refer to our web site www.florim.com for technical information related to CE labeling - Pour tout renseignement sur l'avis technique de la marque CE veuillez consulter le site www.florim.com - Informationen bezüglich technischer Daten zur Beschriftung CE entnehmen Sie unserer Website www.florim.com - For informaciones sobre datos técnicos sobre marca CE mirar al sito www.florim.com



CERTIFICAZIONI

CERTIFICATIONS

CERTIFICATIONS

ZERTIFIZIERUNGEN

CERTIFICACIONES

CERTIFICAZIONI - CERTIFICATIONS - CERTIFICATIONS - ZERTIFIZIERUNGEN CERTIFICACIONES

Certificazione di sistema / System certification / Certification de système / Systemzertifizierung / Certificación de sistema

La soddisfazione del Cliente, nel rispetto dell'Ambiente e della Sicurezza dei propri collaboratori, è la condizione essenziale per il successo della nostra azienda. Di conseguenza, Florim si impegna a porre come obiettivo prioritario il costante miglioramento dei propri prodotti e servizi. Florim Ceramiche S.p.A SB è la prima azienda nel settore a ottenere la certificazione del proprio Sistema di Gestione della Qualità, dell'Ambiente e della Salute e Sicurezza dei lavoratori e dell'Energia, in base alle norme **UNI EN ISO 9001, UNI EN ISO 14001, ISO 45001 e UNI EN ISO 50001**, relativamente a progettazione, produzione e vendita di piastrelle ceramiche in tutte le tipologie produttive.

Customer satisfaction, together with respect for the environment and for the safety of those who work with us are essential conditions for our company's success. As a result, Florim is committed to making the constant improvement of its products and services a priority. Florim Ceramiche S.p.A SB is the first company in the sector to obtain certification for its Quality Management System, its Environmental Management System and its Management System for the Health and Safety of workers and energy, according to **UNI EN ISO 9001, UNI EN ISO 14001, ISO 45001 and UNI EN ISO 50001** standards, relating to the design, manufacture and sales of ceramic tiles in all of its production types.

La satisfaction du client, dans le respect de l'environnement et de la sécurité de ses collaborateurs, est la condition essentielle au succès de notre entreprise. Florim s'engage donc à faire de l'amélioration constante de ses produits et services un objectif prioritaire. Florim Ceramiche S.p.A SB est la première entreprise du secteur à obtenir la certification de son système de gestion de la qualité, de l'environnement, de la santé et de la sécurité des employés et de énergie, conformément aux normes **UNI EN ISO 9001, UNI EN ISO 14001, ISO 45001 et UNI EN ISO 50001**, en matière de conception, production et vente de tous types de carreaux céramiques.

Die Zufriedenheit des Kunden unter Berücksichtigung von Umwelt und Sicherheit unserer Mitarbeiter ist die grundlegende Bedingung für den Erfolg unseres Unternehmens. Demzufolge setzt sich die Firma Florim dafür ein, die ständige Verbesserung ihrer Produkte und Dienstleistungen zum vorrangigen Ziel zu machen. Die Firma Florim Ceramiche S.p.A SB ist das erste Unternehmen in diesem Fachbereich, das die Zertifizierung seines Managementsystems der Qualität, Umwelt und Gesundheit und Sicherheit, und energie auf Grund der Bestimmungen **UNI EN ISO 9001, UNI EN ISO 14001, ISO 45001 und UNI EN ISO 50001**, in Bezug auf Entwurf, Produktion und Verkauf von Keramikfliesen in allen Herstellungsarten erhielt.

La satisfacción del Cliente, con un respeto total del ambiente y seguridad de sus colaboradores, representa la condición esencial para el éxito de nuestra empresa. Por ello, Florim se compromete a perseguir, como objetivo prioritario, una mejora constante de sus productos y servicios. Florim Ceramiche S.p.A SB es la primera empresa en el sector que ha obtenido el certificado del Sistema de Gestión de la Calidad, Ambiente, Salud y Seguridad de los trabajadores y energía en base a la normativa **UNI EN ISO 9001, UNI EN ISO 14001, BS OHSAS 18001 y UNI EN ISO 50001**, en relación al proyecto, producción y venta de baldosas de cerámica en todas las tipologías productivas.



Certificazioni ambientali di prodotto / Product environmental certifications / Certifications environnementales des produits Produktzertifizierungen im zeichen des umweltschutzes / Certificaciones ambientales de producto



GREENGUARD

Certification is the very first voluntary North American indoor air quality product certification created specifically for commercial building products, this certification requires that products meet stringent chemical emissions requirements for over 360 VOCs, plus a limit on the total of all chemical emissions combined. Products undergo routine monitoring and annual retesting to ensure continued compliance with the **GREENGUARD** Certification standard.



GREENGUARD GOLD

Certification was developed with the specific health sensitivities of children and other vulnerable health populations in mind and based on key criteria from public health agencies, this certification sets some of the world's most stringent emission limits on over 360 chemicals, a limit on total chemical emissions, and a limit on phthalate emissions. Products undergo routine monitoring and annual retesting to ensure continued compliance with the **GREENGUARD Gold** standard.

GREENGUARD / GREENGUARD GOLD

Per ulteriori informazioni e approfondimenti / For further details and information / Pour approfondir et obtenir de plus amples informations
Für weitere Informationen / Para obtener más información

Certificazioni ambientali di prodotto / Product environmental certifications / Certifications environnementales des produits
Produktzertifizierungen im Zeichen des Umweltschutzes / Certificaciones ambientales de producto



BUREAU VERITAS

Bureau Veritas è il marchio che certifica la natura riciclata del materiale di cui è composto un prodotto, sottoponendo a verifica l'intero ciclo produttivo. Viene controllata e documentata la provenienza dei materiali di riciclo, il loro dosaggio, il rispetto di alcune peculiarità tecnologiche e il raggiungimento dei parametri stabiliti della norma ISO14021:2002 dell'International Organization for Standardization e del regolamento LEED 2.2 NC del U.S. Green Building Council (USGBC). Per maggiori informazioni: www.bureauveritas.com

Bureau Veritas is the mark that certifies the recycling of the material that goes into the making of a product, by running an inspection on the entire production cycle. Checks and documentation are carried out on the provenance of the recycled material, the quantities used, the observance of certain technological particulars and the achievement of the parameters established by the ISO14021:2002 regulations of the International Organization for Standardization and the LEED 2.2 NC regulation of the U.S. Green Building Council (USGBC). For more information: www.bureauveritas.com

Bureau Veritas est une marque qui certifie que le matériau dont un produit est composé a été recyclé, en soumettant l'ensemble du cycle de production à une vérification. La provenance des matériaux recyclés est contrôlée et prouvée, de même que leur dosage et le respect de certaines caractéristiques technologiques et des paramètres définis par la norme ISO14021:2002 de l'Organisation internationale de normalisation et le règlement LEED 2.2 NC de l'U.S. Green Building Council (USGBC). Pour plus d'informations : www.bureauveritas.com

Bureau Veritas ist ein Markenzeichen, das die rezyklierte Art des Materials zertifiziert, aus dem ein Produkt besteht und dazu den gesamten Produktionszyklus prüft. Kontrolliert und beurkundet wird die Herkunft der rezyklierten Materialien, deren Dosierung, die Einhaltung einiger technologischer Eigenschaften und das Erreichen der Parameter, die von den Vorschriften ISO14021:2002 der International Organization for Standardization und von den LEED-Vorschriften 2.2 NC des U.S. Green Building Council (USGBC) vorgeschrieben werden. Für weitere Infos siehe: www.bureauveritas.com

Bureau Veritas es la marca que certifica la naturaleza reciclada del material con el que está hecho un producto, sometiendo a control todo el ciclo productivo. Se controla y documenta la proveniencia de los materiales reciclados, su dosificación, que se respeten algunas peculiaridades tecnológicas y que se alcancen los parámetros establecidos por la norma ISO14021:2002 de la International Organization for Standardization y del reglamento LEED 2.2 NC del U.S. Green Building Council (USGBC). Para más información: www.bureauveritas.com

Florim e l'ambiente

Florim and the environment / Florim et l'environnement / Florim und die Umwelt / Florim y el ambiente



ENVIRONMENT PRIORITY ONE / Using nature's resources responsibly

Per sottolineare l'attenzione e l'impegno verso la tutela dell'ambiente, in accordo con la norma ISO 14021 (Environmental labels and declarations) Florim afferma il proprio impegno nella continua innovazione tecnologica dei processi industriali.

To underline our care for the environment and our pledge to protect it in accordance with the ISO 14021 standards (Environmental labels and declarations), Florim affirms its commitment to continual technological innovation of the industrial processes in order.

Pour prouver l'attention qu'elle consacre depuis toujours à la protection de l'environnement, en accord avec la norme ISO 14021 (Environmental labels and declarations), la société Florim déclare son engagement dans l'innovation technologique continue des processus industriels.

Die Firma Florim möchte ihre Aufmerksamkeit und ihr Engagement zum Schutz der Umwelt gemäß der ISO-Norm 14021 (Environmental labels and declarations) hervorheben und bekräftigt deshalb, dass sie ständig auf technologische Innovation der Industrie prozesse.

Para subrayar la atención y el compromiso adquirido con la tutela del medio ambiente, de acuerdo con la norma ISO 14021 (Environmental labels and declarations) Florim reafirma su dedicación por la continua innovación tecnológica de los procesos industriales.

Associazioni ambientali / Environmental associations / Associations pour l'environnement

Umweltschutzverbände / Asociaciones ambientales



SGBP 2018-1991

Il Green Building Council di Singapore crea partnership pubblico-privato per promuovere soluzioni di settore innovative attraverso l'intera catena del valore degli edifici e della costruzione. Attraverso i suoi prodotti di bioedilizia e i programmi di etichettatura dei servizi di edilizia ecologica, SGBC stabilisce standard elevati e parametri di riferimento per le soluzioni di bioedilizia sia a livello locale che regionale per aiutare a costruire città più sostenibili per una vita migliore. In qualità di rappresentante di Singapore nel World Green Building Council, SGBC contribuisce attivamente al movimento globale di bioedilizia condividendo competenze e conoscenze durante conferenze ed eventi internazionali.

The Singapore Green Building Council forges public-private partnerships to foster innovative industry solutions across the entire building and construction value chain. Through its green building product and green building services labelling programmes, SGBC sets high standards and benchmarks for green building solutions both locally and regionally to help build more sustainable cities for better living. As Singapore's representative on the World Green Building Council, SGBC actively contributes to the global green building movement by sharing expertise and knowledge during international conferences and events.

Certificati di prova / Test certificates / Certifications de produit / Produktzertifizierungen / Certificaciones de producto



I certificati di prova sono disponibili direttamente sui siti Internet dei vari brand, nella sezione Prove Tecniche dedicata alle diverse collezioni.

Per ulteriori informazioni e approfondimenti: www.florim.com

The test certificates are available directly on the websites of the various brands, in the Technical Test section dedicated to the different collections.

For further details and information: www.florim.com

Les certificats de test de performance sont disponibles directement sur les sites Internet des différentes marques, dans la section Essais Techniques consacrée aux différentes collections. Pour approfondir et obtenir de plus amples informations: www.florim.com

Die Prüfbescheinigungen sind direkt auf den Internetseiten der entsprechenden Brands im Bereich Technische Prüfungen der verschiedenen Kollektionen verfügbar. Für weitere Informationen: www.florim.com

Los certificados de ensayo están disponibles directamente en los sitios internet de las diferentes marcas, en la sección Ensayos Técnicos dedicada a las diferentes colecciones. Para obtener más información: www.florim.com

Los certificados de ensayo están disponibles directamente en los sitios internet de las diferentes marcas, en la sección Ensayos Técnicos dedicada a las diferentes colecciones. Para obtener más información: www.florim.com

Marcatura CE / CE Mark / Marquage CE / CE-Kennzeichnung / Marca CE



Per ulteriori informazioni, approfondimenti e download delle marcature CE: www.florim.com

For further details and information and to download the CE marks: www.florim.com

Pour obtenir de plus amples informations, approfondir et télécharger les marquages CE: www.florim.com

Für weitere Informationen und Downloads der CE-Kennzeichnungen: www.florim.com

Para obtener más información y descargar las marcas CE: www.florim.com

Certificazioni di prodotto nazionali / National product certifications / Certifications de produit nationaux

Nationale Produktzertifizierungen Certificaciones de producto nacionales



放射性水平 A 类

Certificazione obbligatoria per l'esportazione in Cina
Certification mandatory for export to China
Certification obligatoire pour l'exportation en Chine
Für den Export nach China obligatorische Zertifizierung
Certificación obligatoria para la exportación a China

Per soddisfare le richieste di norme e regolamenti locali, vi sono anche diverse certificazioni di prodotto nazionali.

Per informazioni in merito contattare www.florim.com

To cater for the requirements of local norms and regulations, various national product certifications also exist. For more details contact www.florim.com

Pour satisfaire les exigences des normes et réglementations locales, il existe également différentes certifications nationales de produit.

Pour de plus amples informations à ce sujet contacter www.florim.com

Darüber hinaus sind auch verschiedene nationale Produktzertifizierungen vorhanden, um die lokalen Anforderungen bezüglich Richtlinien und Reglementen zu erfüllen. Für Informationen dazu wenden Sie sich bitte an www.florim.com

Para satisfacer los requisitos previstos por las normas y reglamentos locales, hay también varias certificaciones de producto nacionales. Para obtener más información, contacte con www.florim.com



UPEC

QB-UPEC

Per informazioni relative ai dati tecnici sulla classificazione UPEC vedi il sito www.florim.com

Pour toute information concernant les données techniques sur la classification UPEC, nous vous prions de bien vouloir consulter la version française du site www.florim.com



WallPEC

QB-WallPEC

Per informazioni relative ai dati tecnici sulla classificazione WallPEC vedi il sito www.florim.com

Pour toute information concernant les données techniques sur la classification WallPEC, nous vous prions de bien vouloir consulter la version française du site www.florim.com

U.S. GREEN BUILDING COUNCIL



Florim ha aderito volontariamente all'U.S. Green Building Council (USGBC), la più importante associazione statunitense di industrie appartenenti al settore edilizio, unite per promuovere edifici costruiti in accordo a precise disposizioni riguardanti la sostenibilità ambientale che sono incluse all'interno della certificazione LEED (Leadership in Energy and Environmental Design), un sistema a punteggio che misura la sostenibilità di un progetto. L'utilizzo di prodotti Florim contribuisce a ottenere punti per l'acquisizione della certificazione LEED.

Florim has voluntarily become a member of the U.S. Green Building Council (USGBC), the most important American association dedicated to environmentally sustainable building design and construction according to precise directives, which must be followed in order to obtain LEED (Leadership in Energy and Environmental Design) certification, a rating system that measures the sustainability of a project. Using Florim products contributes to getting points to achieve LEED certification.

Florim a adhéré volontairement à l'U.S. Green Building Council (USGBC), la plus grande association américaine d'industries appartenant à la filière BTP, unies pour promouvoir la réalisation de constructions conformes aux dispositions précises édictées en matière de durabilité environnementale, incluses dans la certification LEED (Leadership in Energy and Environmental Design), un système d'attribution de notes mesurant la durabilité d'un projet. L'utilisation des produits Florim contribue à l'obtention de points en vue de la certification LEED.

Florim ist freiwillig dem U.S. Green Building Council (USGBC) beigetreten, dem bedeutendsten Verband der Bauindustrien in den Vereinigten Staaten, die sich zur Förderung von Gebäuden vereinigt haben, die gewissen Nachhaltigkeitsvorschriften entsprechend gebaut werden. Diese Bestimmungen sind in der LEED-Zertifizierung (Leadership in Energy and Environmental Design), einem Punktesystem zur Bewertung der Nachhaltigkeit eines Projekts, enthalten. Der Gebrauch von Florim Produkten trägt zur Erlangung von Punkten der LEED-Zertifizierung bei.

Florim ha adherido voluntariamente al U.S. Green Building Council (USGBC), la más importante asociación estadounidense de industrias pertenecientes al sector de la construcción, unidas para promover la construcción de edificios de acuerdo con precisas disposiciones relativas a la sostenibilidad ambiental, que están incluidas en la certificación LEED (Leadership in Energy and Environmental Design), un sistema por puntos que mide la sostenibilidad de un proyecto. El uso de productos Florim contribuye a obtener puntos para adquirir la certificación LEED.

La certificazione LEED è una certificazione di edificio non di prodotto. Pertanto i criteri LEED fanno sempre riferimento al sistema edificio e non ai singoli materiali utilizzati nel progetto. La soglia indicata nei crediti si riferisce quindi al parametro cui l'edificio dovrà conformarsi per l'attribuzione del relativo punteggio. Sul sito Florim.com, All'interno delle certificazioni di ogni singola collezione, è disponibile la Certification Letters for LEED® Projects.

LEED certification is a building certification and not for a product. Therefore, the LEED criteria always refer to the building system and not to the individual building materials used in the project. The threshold indicated in the credits, therefore refers to the parameter to which the building must comply with for the allocation of the corresponding point score. Certification Letters for LEED® Projects are available on the Florim.com website, in the certifications for each single collection.

La certification LEED (« Leadership in Energy and Environmental Design ») est une certification qui concerne les bâtiments et non pas les produits. Ainsi, les critères LEED font toujours référence au système bâtiment et non pas aux matériaux utilisés dans le projet. Le seuil indiqué dans les crédits se réfère donc au paramètre auquel le bâtiment devra se conformer pour l'attribution des points correspondants. Sur le site Florim.com, parmi les certifications de chaque collection, la Certification Letters for LEED® Projects est disponible.

Bei der LEED-Zertifizierung handelt es sich nicht um ein Produkt- sondern ein Gebäudezertifizierungssystem. Daher beziehen sich die LEED-Kriterien immer auf das Gebäude im Ganzen, nicht auf die einzelnen für das Projekt verwendeten Materialien. Der für die Punkte angegebene Grenzwert bezieht sich daher auf den Wert, den das Gebäude einhalten muss, um die entsprechenden Punkte zu erhalten. Auf der Website Florim.com finden sich in den Zertifizierungen der einzelnen Kollektionen die Certification Letters for LEED® Projects.

La certificación LEED es una certificación para el edificio y no para el producto. Por lo tanto los criterios LEED siempre se refieren al sistema edificio y no a cada uno de los materiales utilizados en el proyecto. El umbral indicado en los créditos se refiere por lo tanto al parámetro al cual el edificio se deberá ajustar para que le sea atribuida la correspondiente puntuación. En el sitio web Florim.com, en la sección de las certificaciones de cada colección, están disponibles las Certification Letters for LEED® Projects.



ENVIRONMENTAL PRODUCT DECLARATION

L'EPD è una Dichiarazione Ambientale di Prodotto certificata e verificata in modo indipendente, che esprime in modo trasparente e oggettivo le prestazioni ambientali di un prodotto lungo il suo ciclo di vita, in accordo con lo Standard internazionale ISO14025. L'EPD è basata su specifiche regole che ne definiscono le metodologie di calcolo: le Product Category Rules (PCR), e non prevede soglie prestazioni.

The EPD is a certified and independently verified Environmental Product Declaration that expresses in a transparent and objective manner the environmental performance of a product throughout its life cycle, in accordance with the International Standard ISO14025. The EPD is based on specific rules that define the calculation methodologies: the Product Category Rules (PCR), and does not provide for performance thresholds.

La DEP est une Déclaration Environnementale de Produit certifiée et vérifiée de façon indépendante, décrivant de manière transparente et objective les performances environnementales d'un produit tout au long de son cycle de vie, conformément à la norme internationale ISO 14025. La DEP s'appuie sur des règles spécifiques qui définissent ses méthodes de calcul : les Product Category Rules (PCR), et ne prévoit pas de seuils de performance.

EPD ist eine zertifizierte und unabhängig kontrollierte Produkt-Umwelterklärung, die, übereinstimmend mit der internationalen Norm ISO14025, auf transparente und objektive Weise die Umweltleistungen eines Produkts während seines Lebenszyklus bekundet. EPD basiert auf spezifischen Regeln, die die Berechnungsmethode festlegen: die Product Category Rules (PCR), die keine Leistungsschwellen vorsehen.

La DAP es una declaración ambiental de producto, certificada y verificada de manera independiente, que informa acerca del desempeño ambiental de un producto a lo largo de su ciclo de vida de forma transparente y objetiva, de conformidad con la norma internacional ISO 14025. La DAP se basa en reglas específicas que definen sus métodos de cálculo, denominadas Reglas de categoría de producto (RCP), y no prevé umbrales de desempeño.



CONDIZIONI GENERALI DI VENDITA

GENERAL CONDITIONS OF SALE
CONDITIONS GÉNÉRALES DE VENTE
ALLGEMEINE GESCHÄFTSBEDINGUNGEN
CONDICIONES GENERALES DE VENTA